

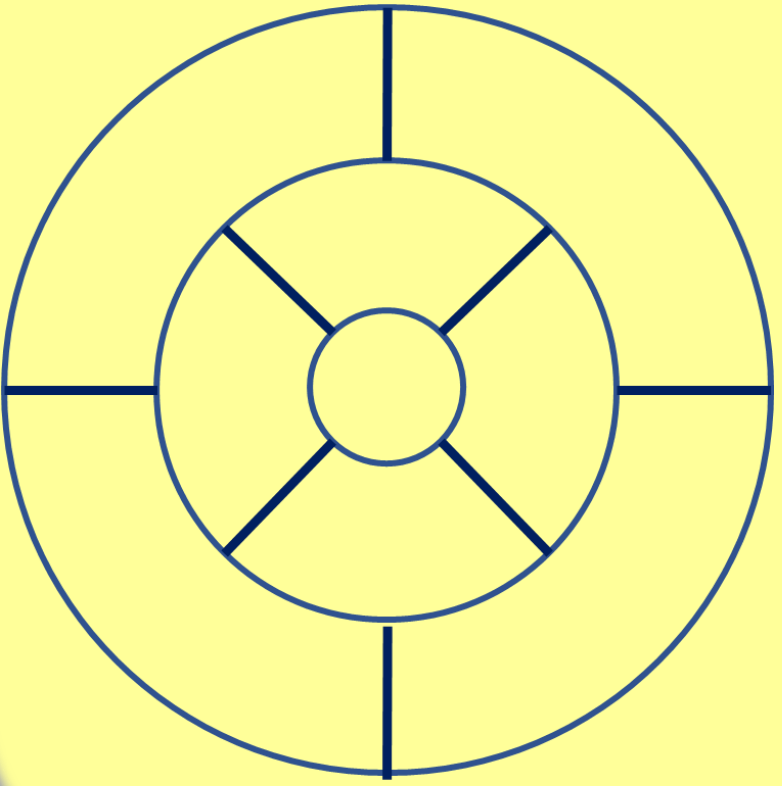

هوش ریاضی

ثابت تغییر

در این مدل سوالا یک عدد در مرکز قرار گرفته با عملیات های مختلف اعداد دور خود را ایجاد می کند.



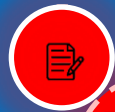

حوش ریاضی

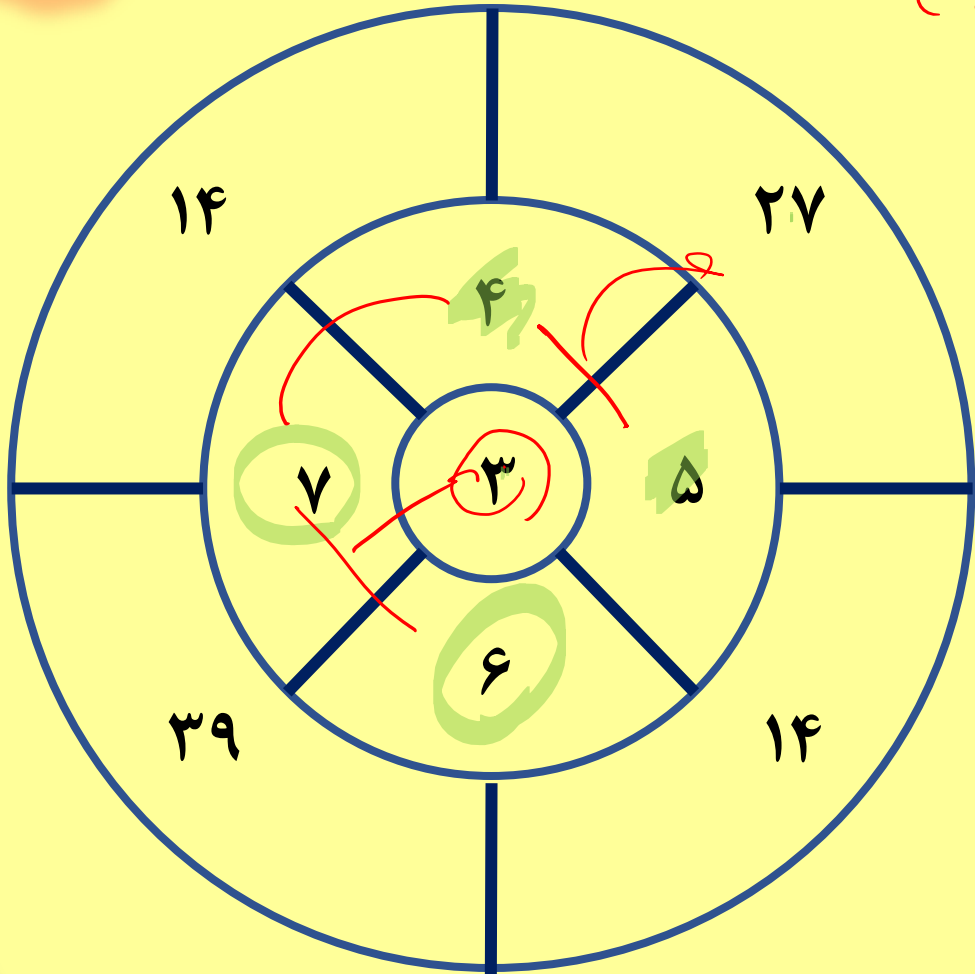

$$(2+8) \times 3 = 30$$

$$(7+4) \times 3 = 33$$

$$(5+4) \times 3 = 27$$

$$(6+7) \times 3 = 39$$

هوش ریاضی

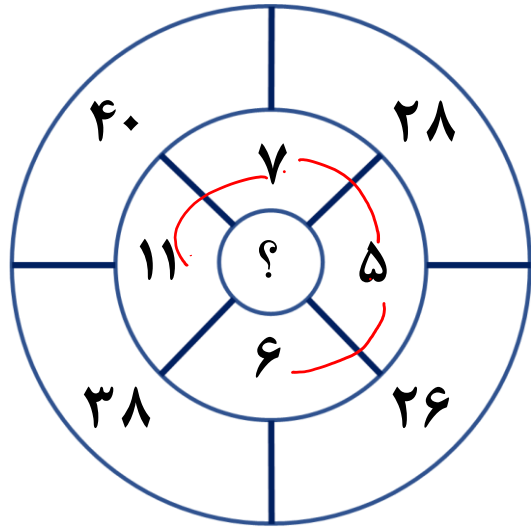

مقدار علامت سوال کدام است؟

$$(7 + 5 + 2) \times 2 = 28$$

$$(7 + 6 + 2) \times 2 = 24$$

$$(11 + 7 + 2) \times 2 = 40$$

۴ ۱

۷ ۲

۲ ۳

۵ ۴



هوش ریاضی

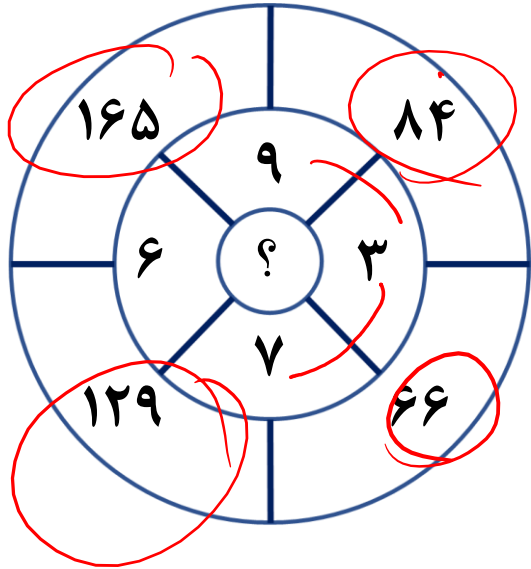

$$\overset{21}{(2 \times 7)} \times 2 + 2 = 44$$

$$(9 \times 3) \times 2 + 3 = 66$$

مقدار علامت سوال کدام است؟

۱

۲

۳

۴

2 ✓

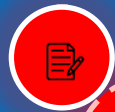

هوش ریاضی

دارت اعداد

تو این جور سوالا اعداد داخل چند لایه قرار گرفتن ، یا اعداد لایه های بیرون داخلی رو می سازن یا برعکس

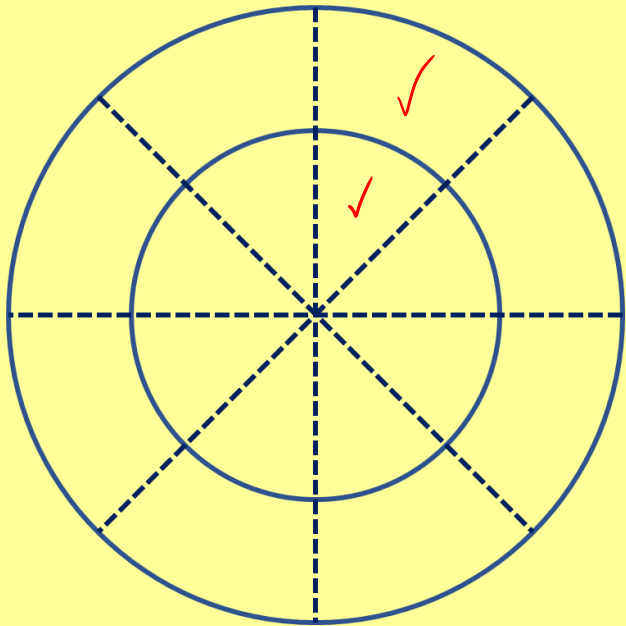

۱

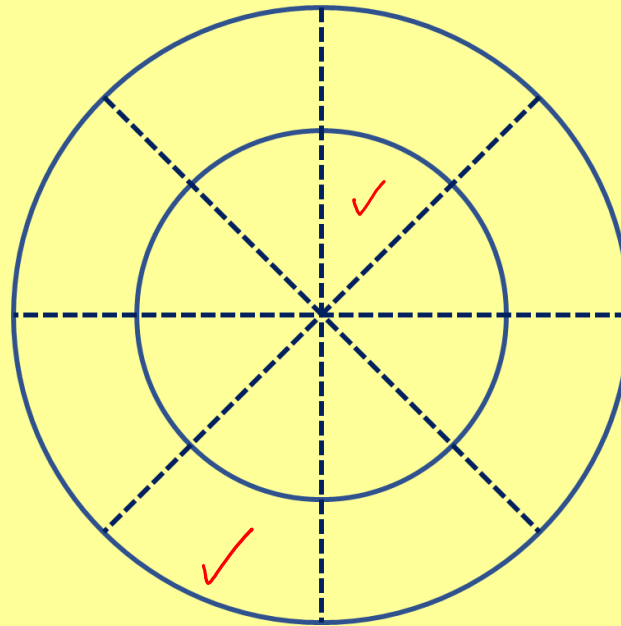

۲

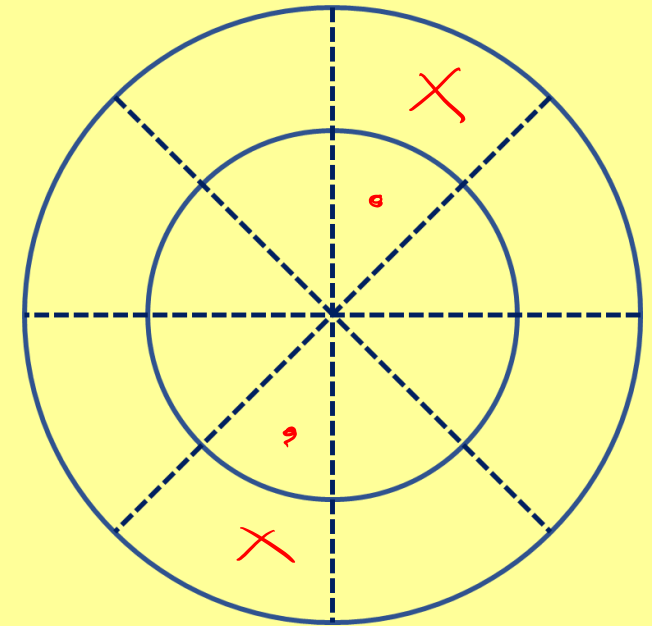

۳

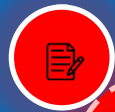

حوش ریاضی

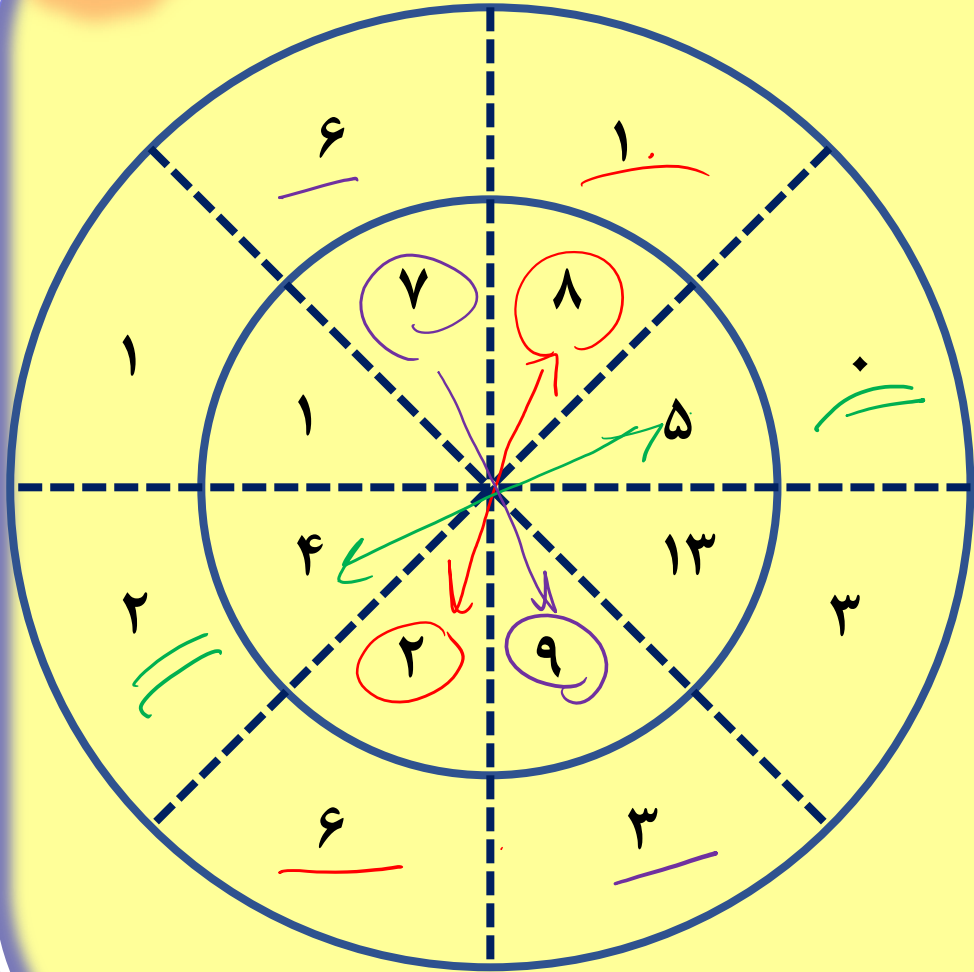

$$2 \times 7 = 14$$

$$5 \times 9 = 45$$

حوش ریاضی

$$\sqrt{28} = 28 \rightarrow 2 + 8 = 10$$

مقدار علامت سوال کدام است؟

$$0 \times 4 = 0 \rightarrow 0 + 0 = 0$$

$$2 \times 2 = 4 \rightarrow 4$$

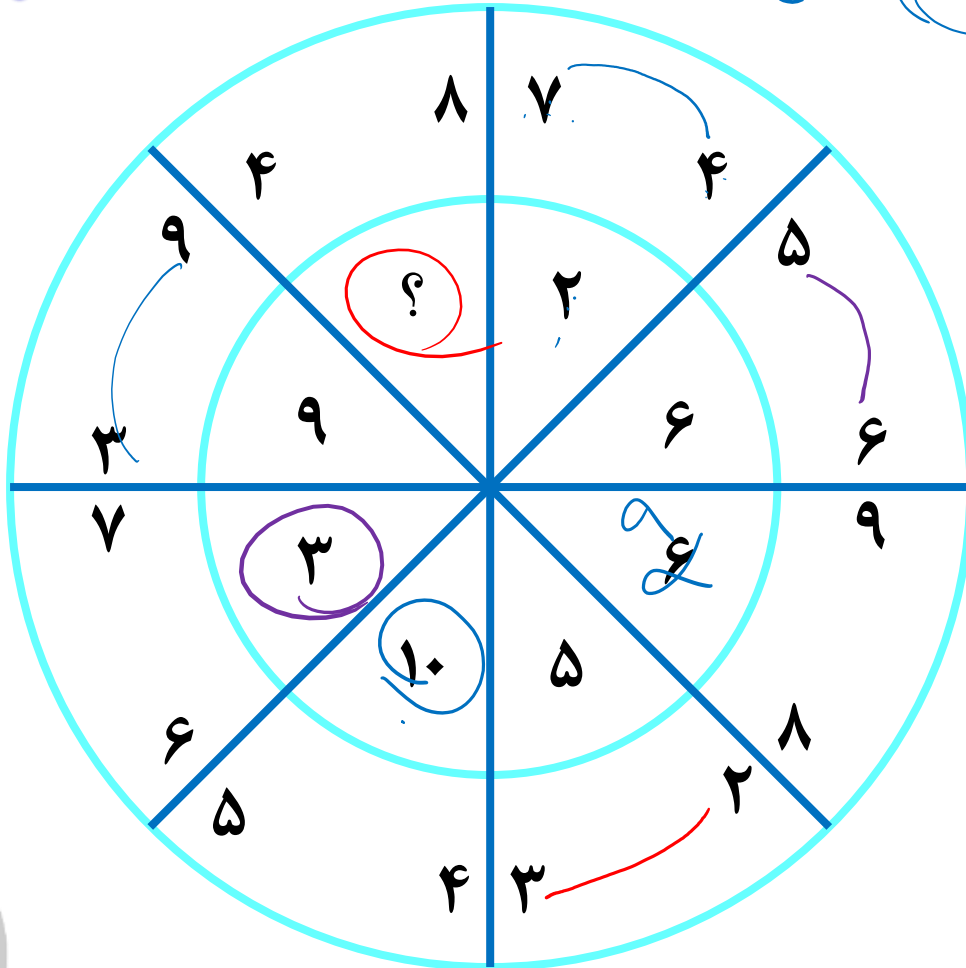

- 6 1
- 8 2
- 3 3
- 18 4

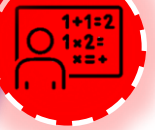

حوش ریاضی

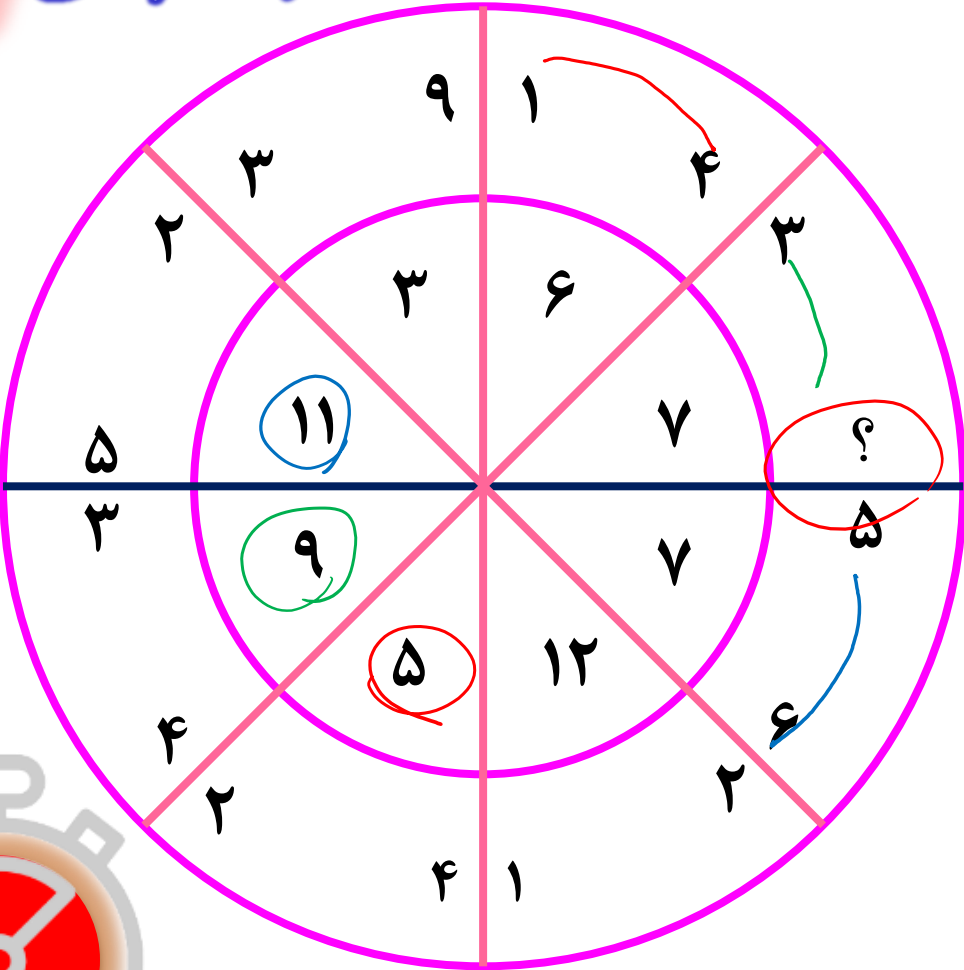
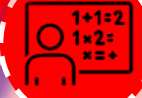

مقدار علامت سوال کدام است؟

- ۱۶ ۱
- ۶ ۲
- ۱۸ ۳
- ۸ ۴





هوش ریاضی

الگوهای مرکزگرا

در این مدل سوالا یک سری عدد دور عدد دیگر قرار گرفته اند و با عملیات مختلف عدد وسط را می سازند

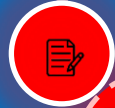

هوش ریاضی

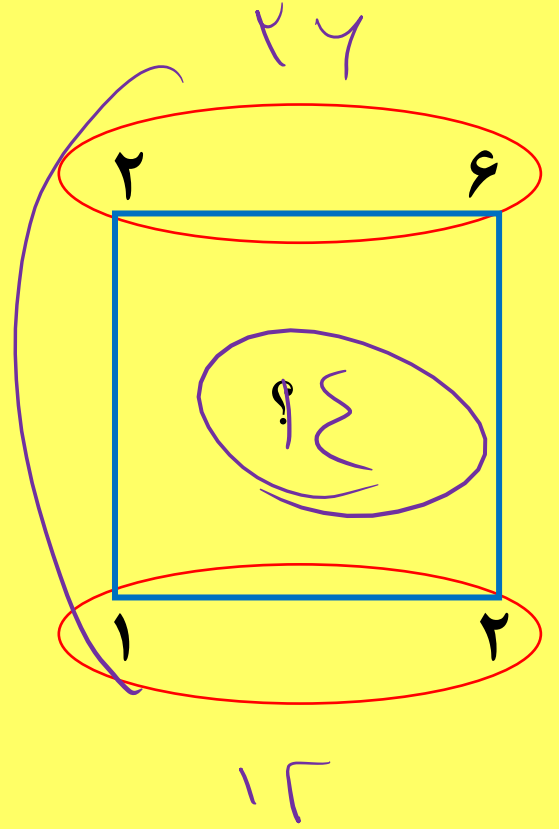
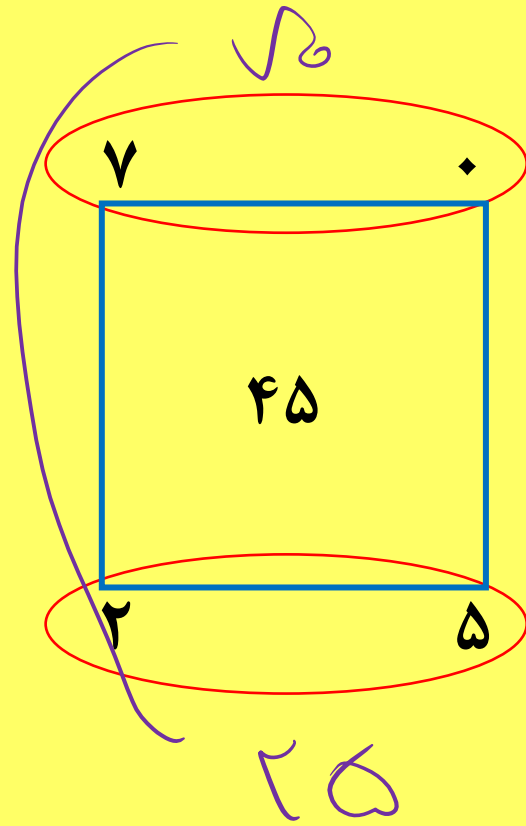
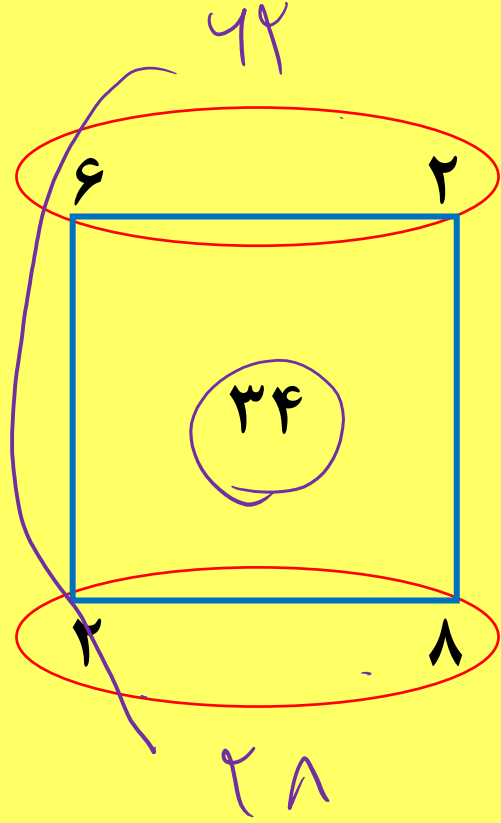
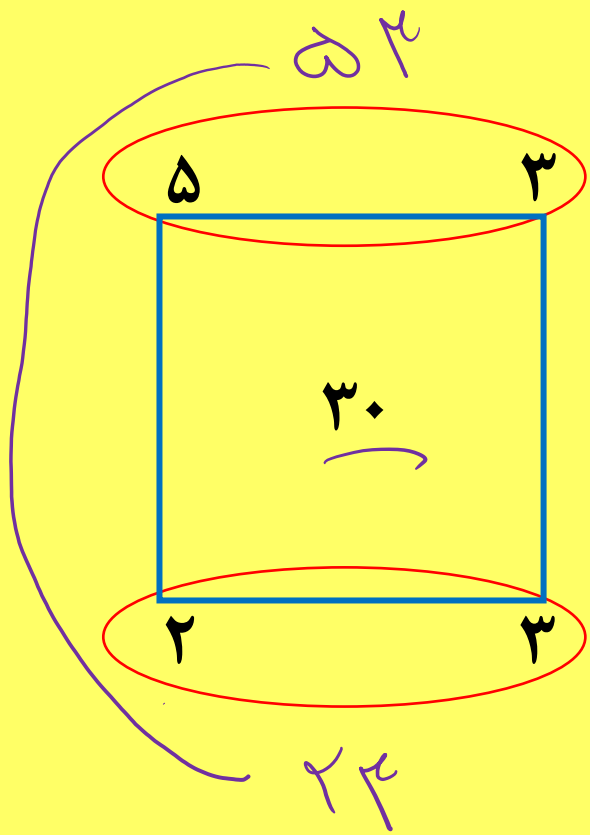

به جای علامت سوال چه عددی قرار می گیرد؟

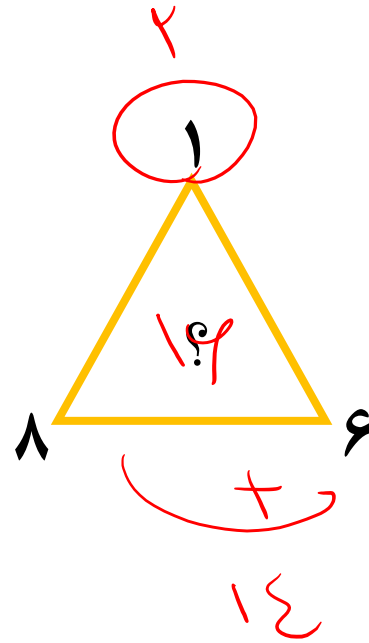
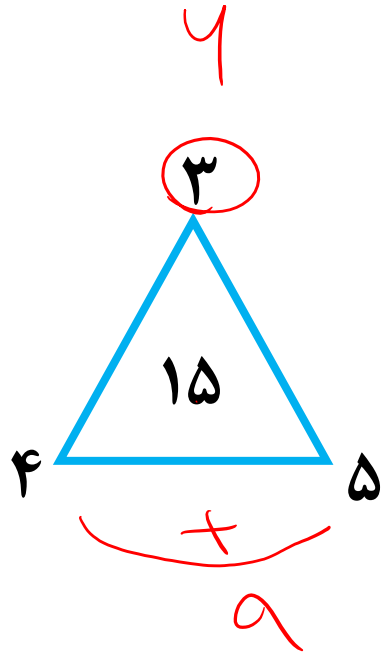
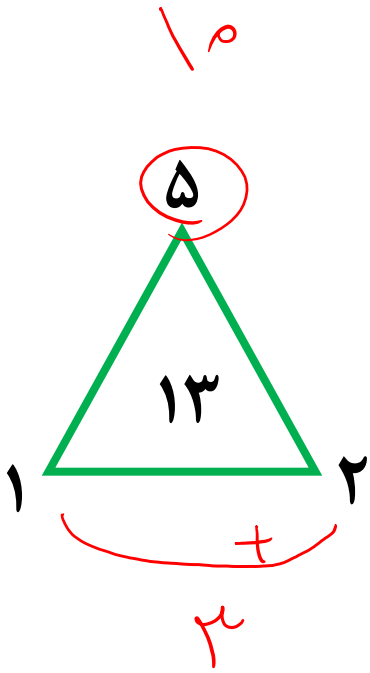

۱۲ ۱

۱۴ ۲

۱۶ ۳

۱۸ ۴



مقدار علامت سوال کدام است؟

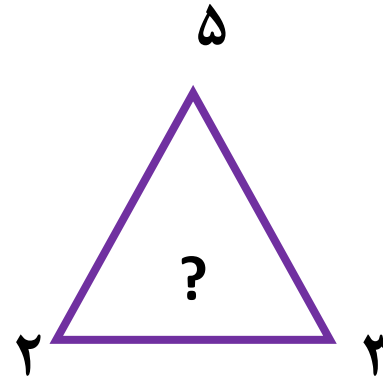
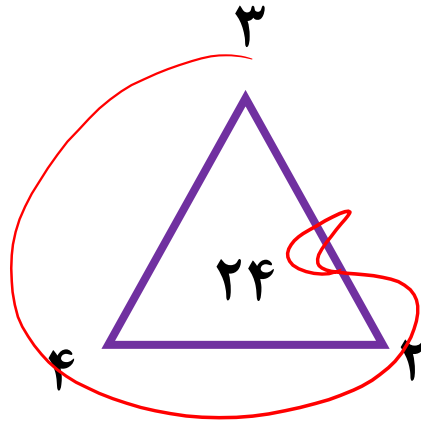
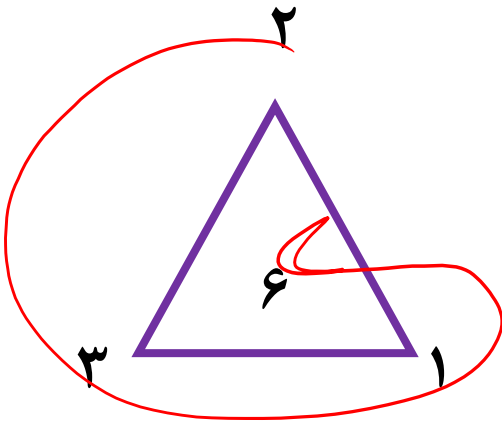

- ۳۰ ۱
- ۳۵ ۲
- ۴۰ ۳
- ۴۵ ۴



مقدار علامت سوال کدام است؟

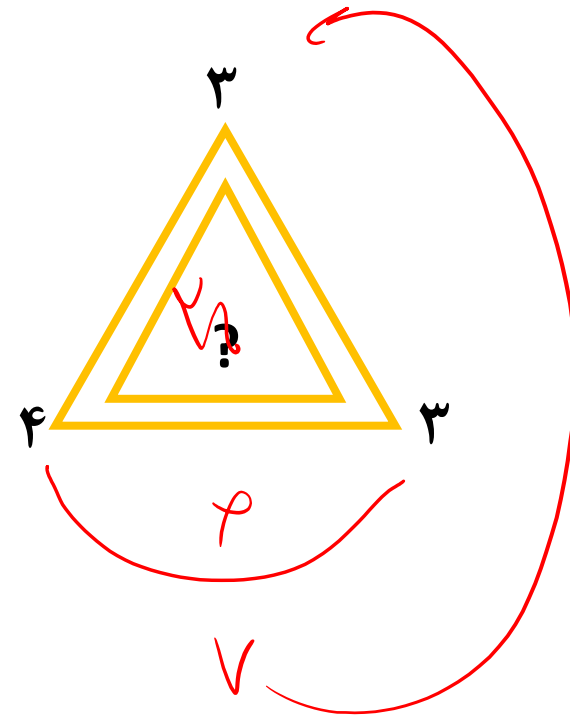
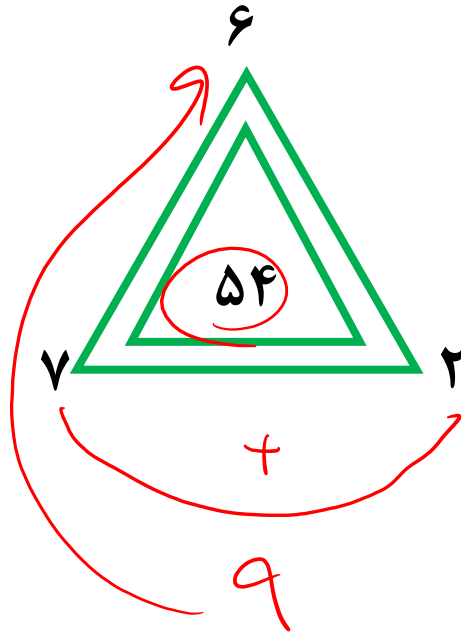
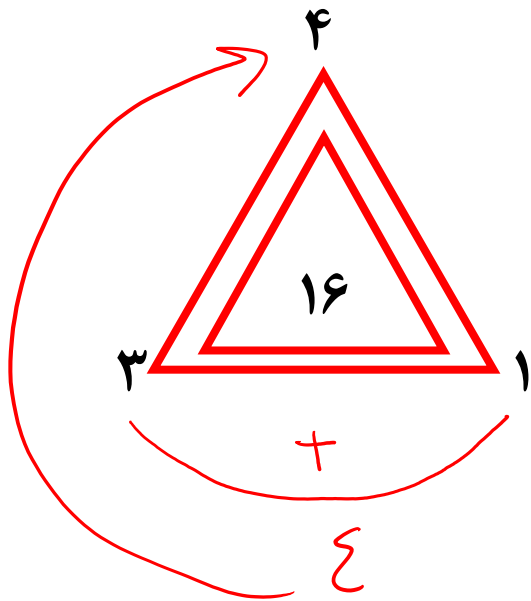

- ۲۱
- ۲۴
- ۳۴
- ۳۶





هوش ریاضی

تست

مقدار علامت سوال کدام است؟

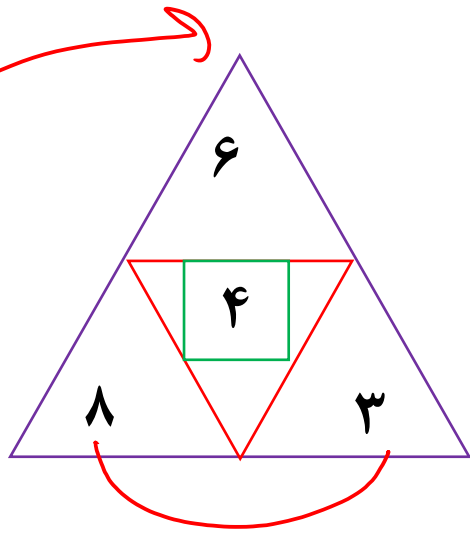

x
۲۶

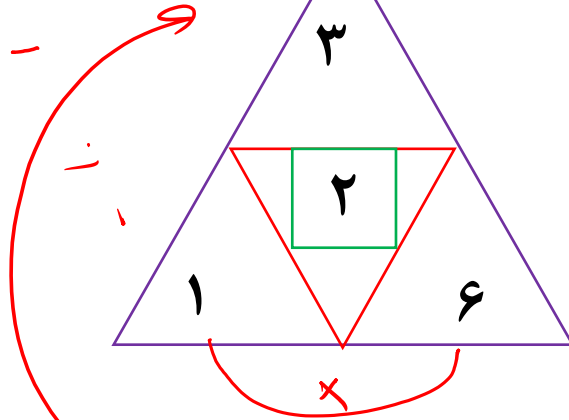

x
۶

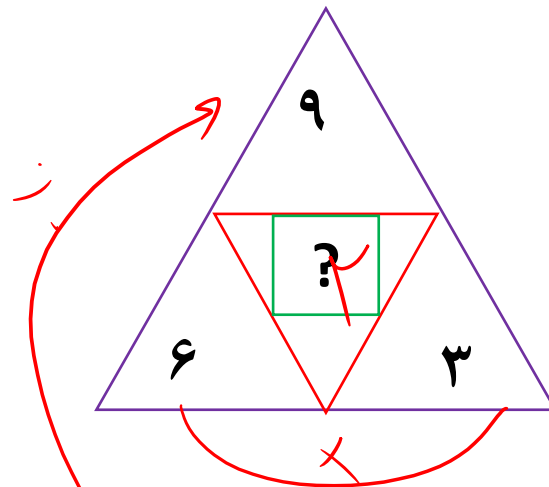

x
۱۷

~~۱~~
۲

۲
۴

۳
۶

۴
۸





هوش ریاضی

تست

مقدار علامت سوال کدام است؟

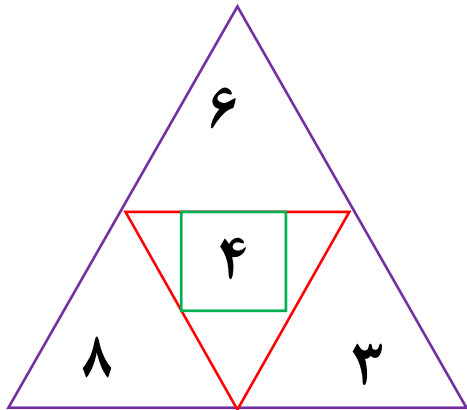

$$\frac{1 \times 3}{6} = 4$$

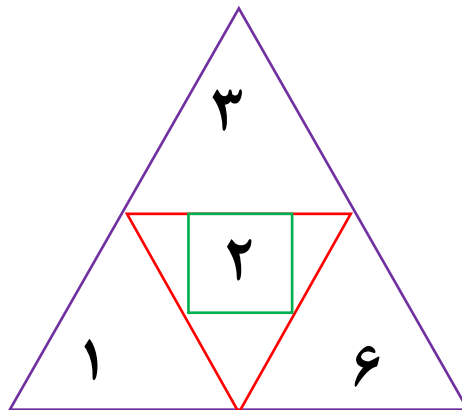

$$\frac{1 \times 6}{4} = 2$$

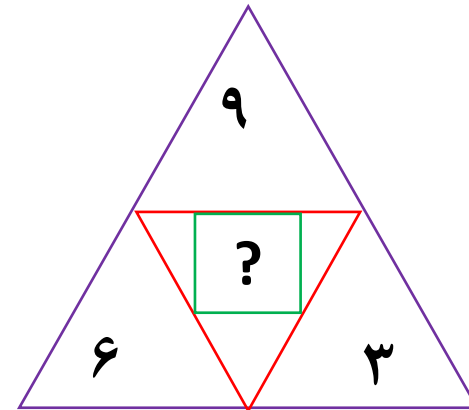

$$\frac{6 \times 3}{9} = ?$$

- ۱
- ۲
- ۳
- ۴



مقدار علامت سوال کدام است؟

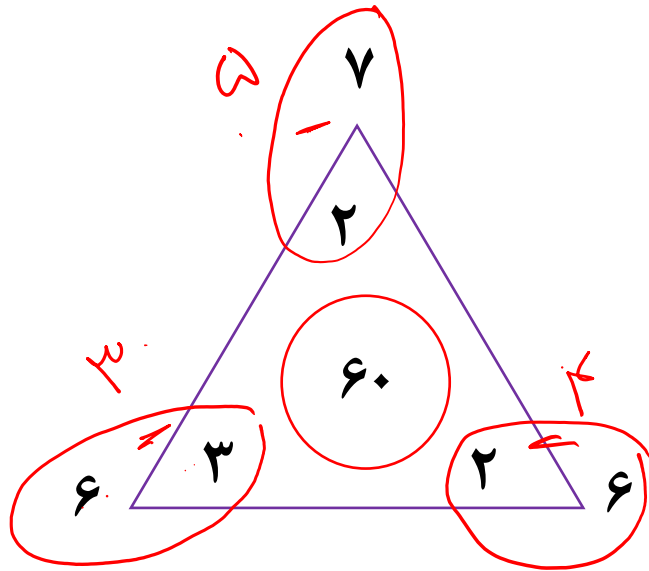

$$5 \times 3 \times 4 = 60$$

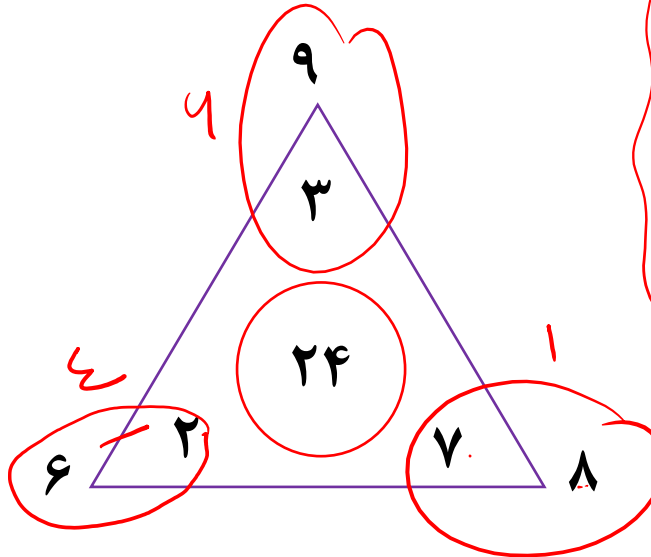

$$4 \times 3 \times 1 = 12$$

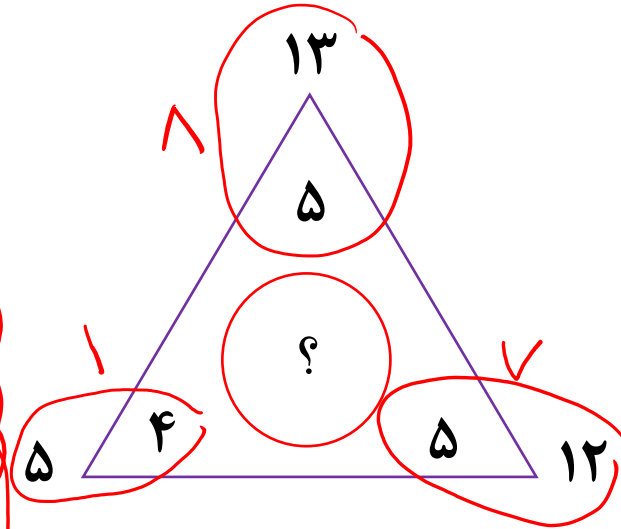

$$1 \times 7 = 84$$

- ۴۲ ۱
- ۴۸ ۲
- ۵۶ ۳
- ۶۴ ۴



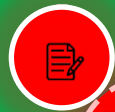

هوش ریاضی

تست

مقدار علامت سوال کدام است؟

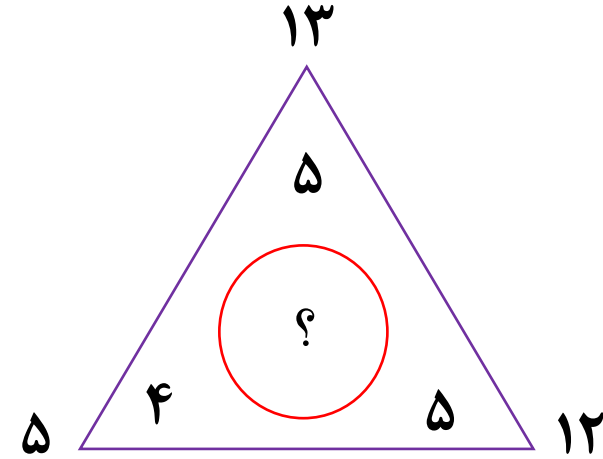
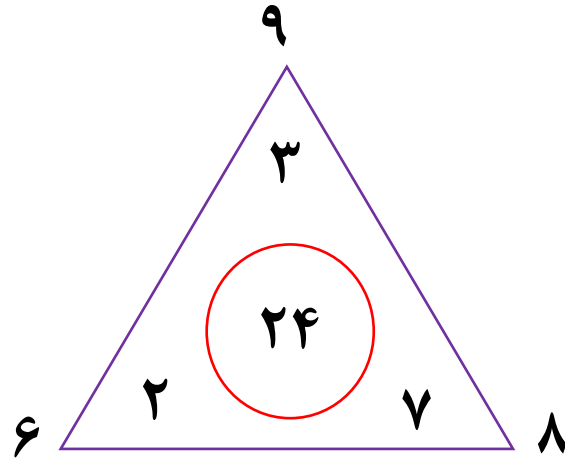
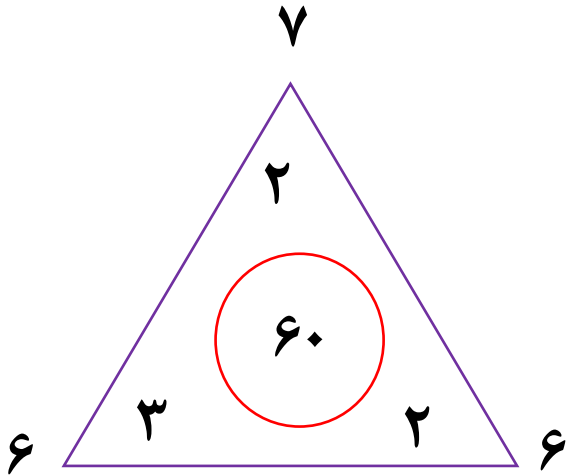

۴۲

۴۸

۵۶

۶۴

$$(7-2) \times (6-2) \times (6-2) = 60$$

$$(9-3) \times (8-7) \times (8-2) = 24$$

$$(13-5) \times (12-5) \times (5-4) = 56$$





هوش ریاضی

تست

مقدار علامت سوال کدام است؟

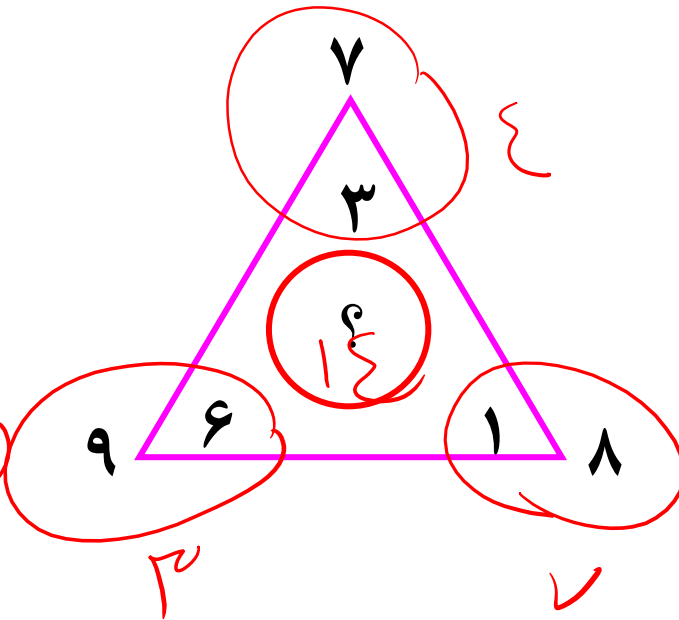
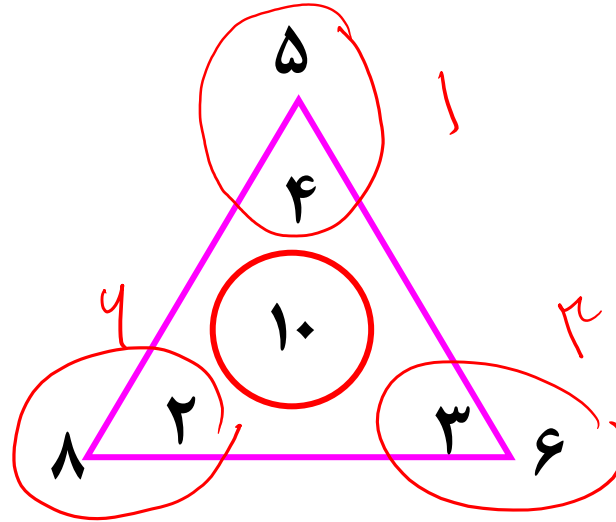
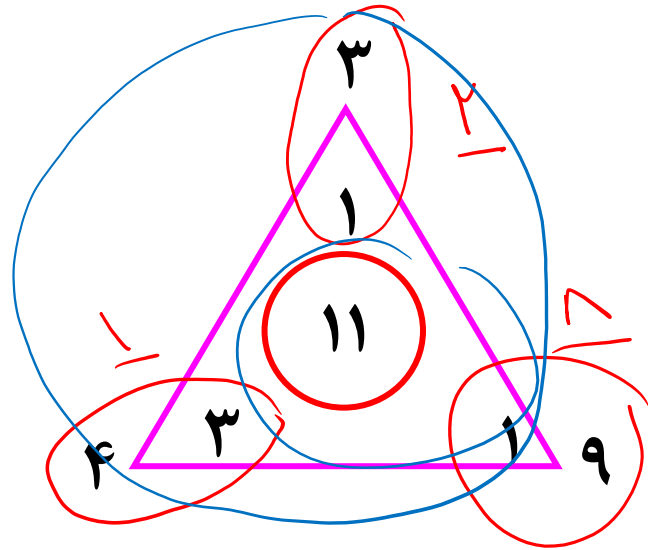

- ۸ ۱
- ۱۰ ۲
- ۱۲ ۳
- ۱۴ ۴

$(2 + 1 + 9)$
 $(4 + 3 + 1)$



مقدار علامت سوال کدام است؟

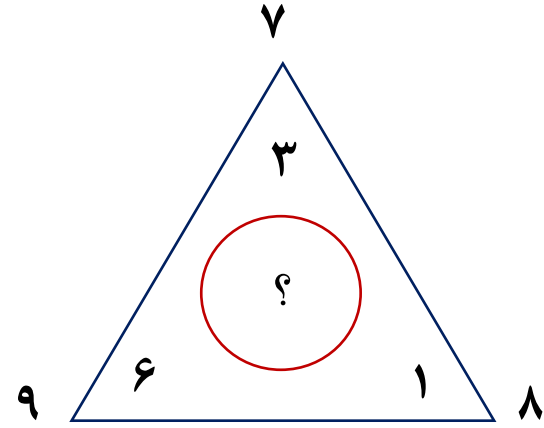
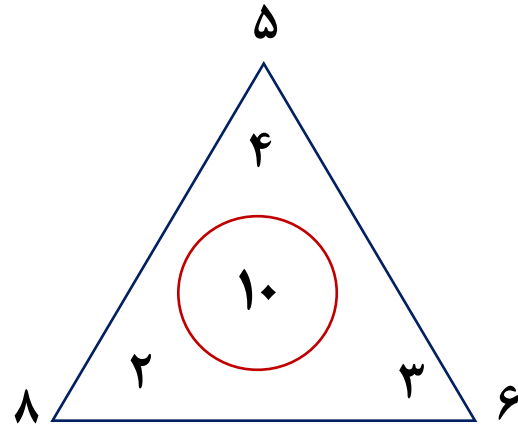
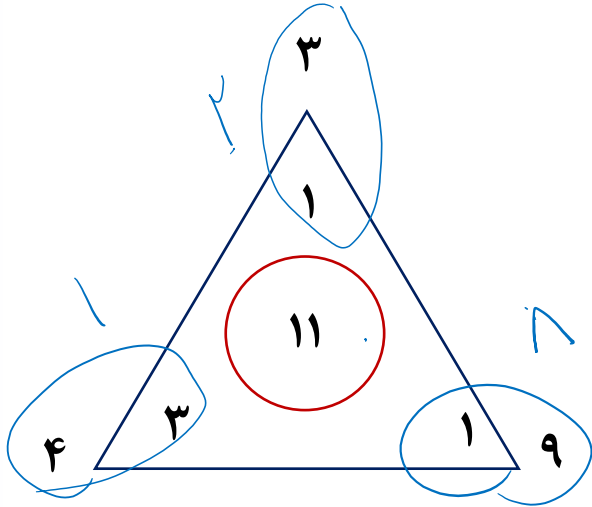

۸ ۱

۱۰ ۲

۱۲ ۳

۱۴ ۴

$$(3-1) + (4-3) + (9-1) = 11$$

$$(5-4) + (8-2) + (6-3) = 10$$

$$(7-3) + (9-6) + (8-1) = 14$$

$$(3+4+9) - (1+1+2) = 11$$





هوش ریاضی

تست

مقدار علامت سوال کدام است؟

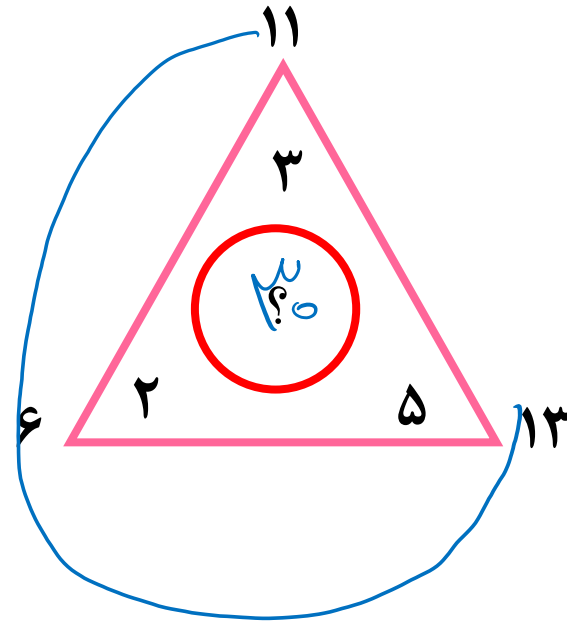
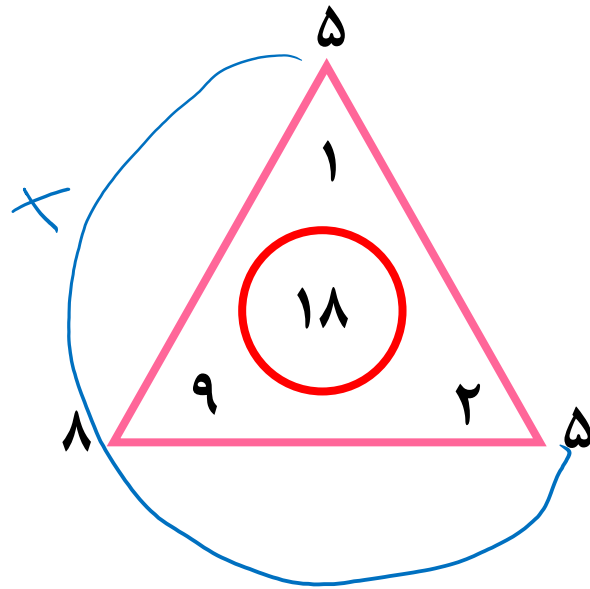
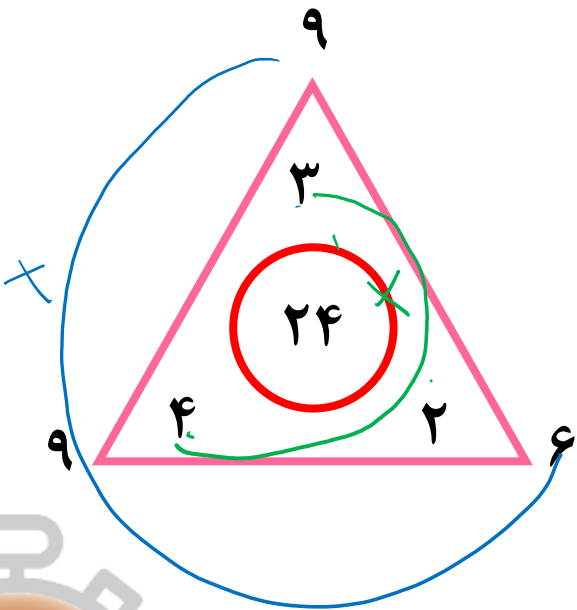

24

30

32

36



هوشلند

موسسه تخصصی زبان



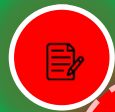

هوش ریاضی

تست

مقدار علامت سوال کدام است؟

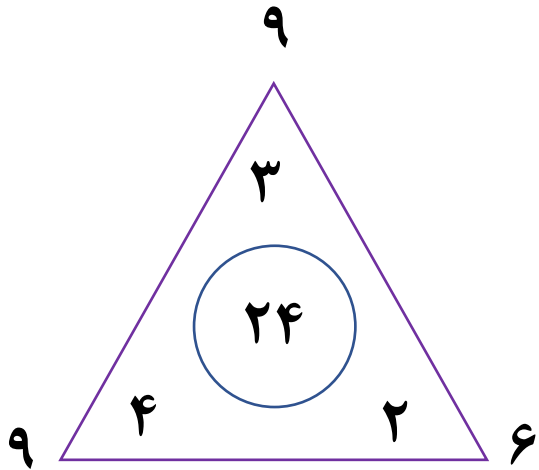

$$(9+6+9) = (3 \times 4 \times 2) = 24$$

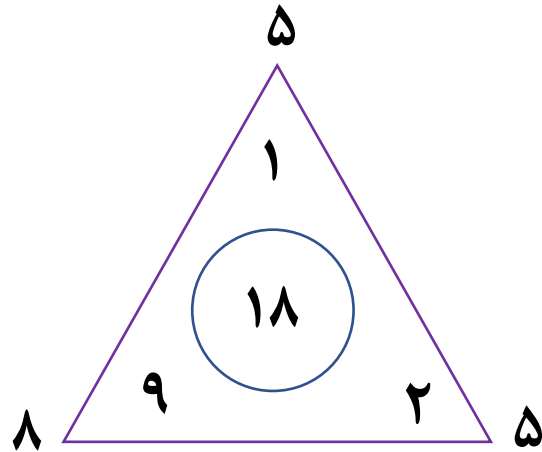

$$(5+8+5) = (1 \times 9 \times 2) = 18$$

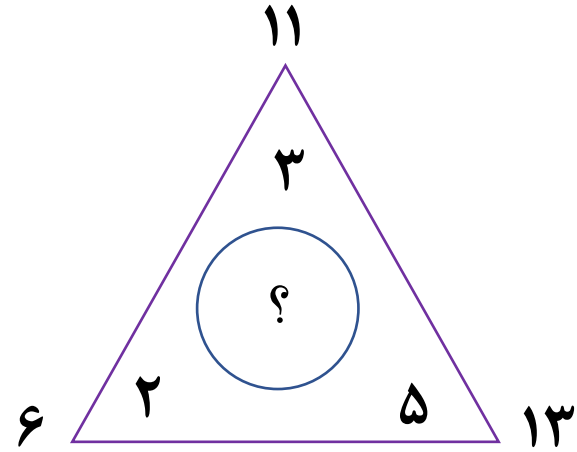

$$(11+6+13) = (3 \times 2 \times 5) = 30$$

۲۴

۳۰

۳۲

۳۶





هوش ریاضی

شماره ارقام

نکته: ...

تست

مقدار علامت سوال کدام است؟

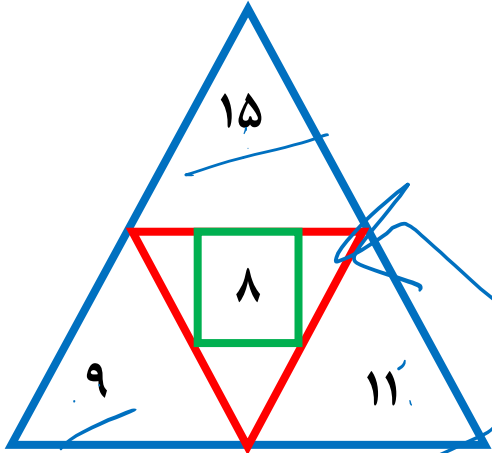

$$15 + 9 + 11 = 35$$

$$3 + 5 = 8$$

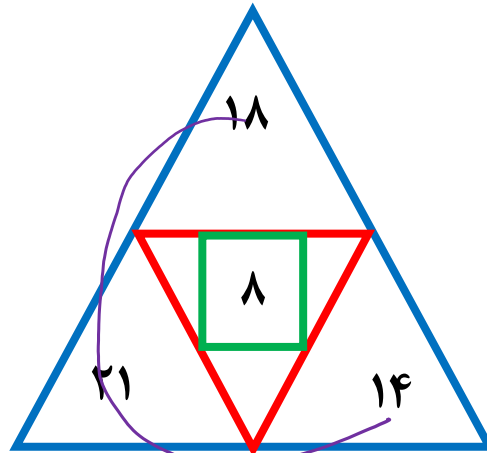

$$18 + 21 + 14 = 53$$

$$5 + 3 = 8$$

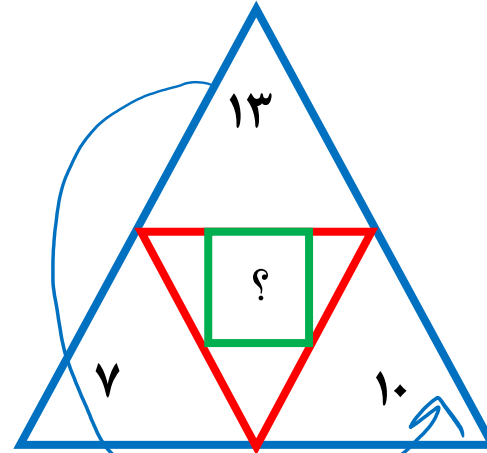

$$13 + 7 + 10 = 30$$

$$3 + 0 = 3$$

۴ ۱

۶ ۲

۸ ۳

۳ ۴





هوش ریاضی

تست

مقدار علامت سوال کدام است؟

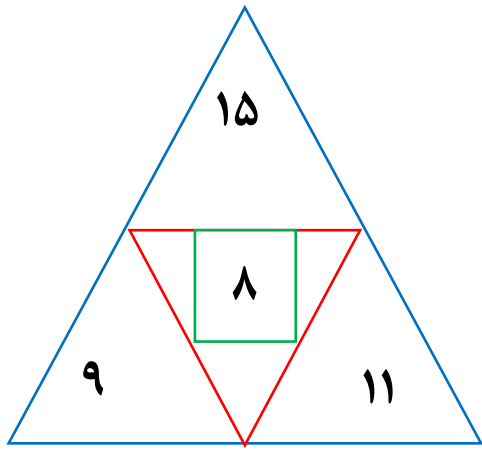

$$15 + 9 + 11 = 35$$

$$3 + 5 = 8$$

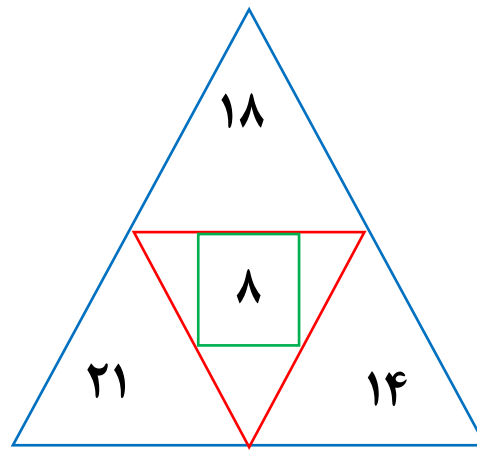

$$18 + 21 + 14 = 53$$

$$5 + 3 = 8$$

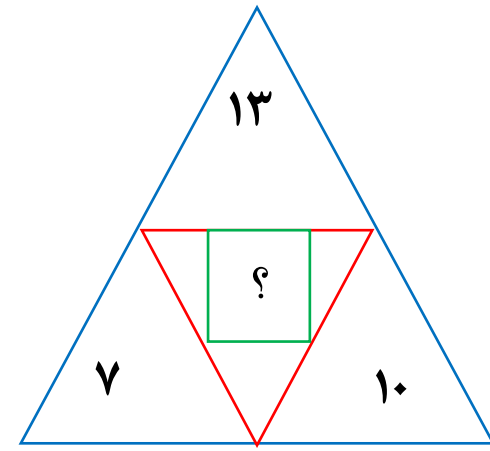

$$13 + 7 + 10 = 30$$

$$3 + 0 = 3$$

- ۴ ۱
- ۶ ۲
- ۸ ۳
- ۳ ۴





هوش ریاضی

تست

مقدار علامت سوال کدام است؟

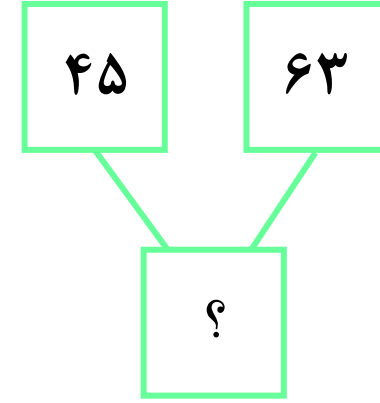
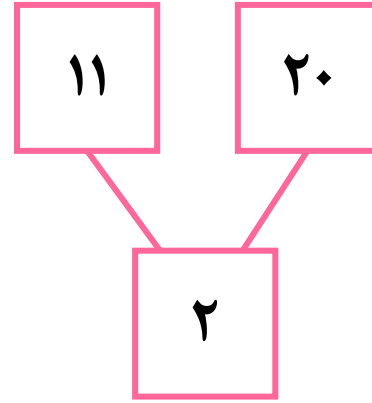
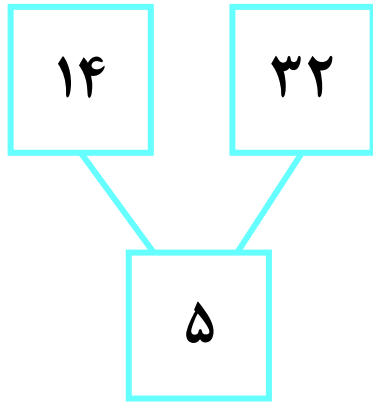
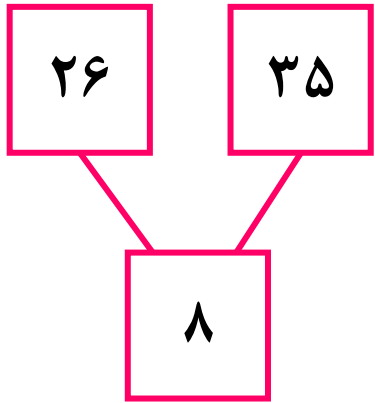

- ۳ ۱
- ۶ ۲
- ۹ ۳
- ۱۲ ۴



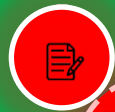

هوش ریاضی

تست

مقدار علامت سوال کدام است؟

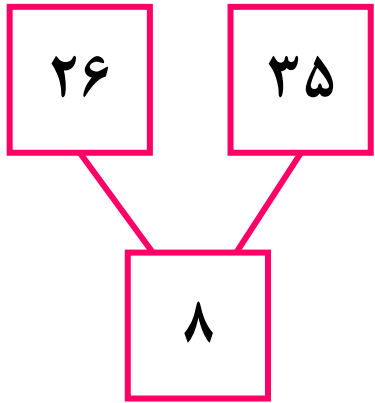

$2+6=8$

$3+5=8$

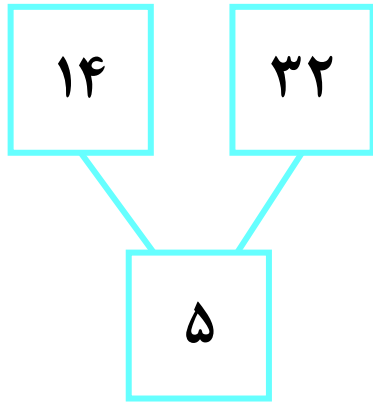

$1+4=5$

$3+2=5$

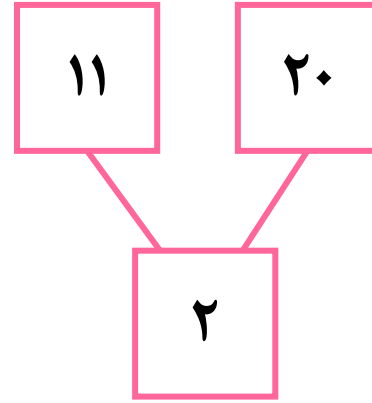

$1+1=2$

$2+0=2$

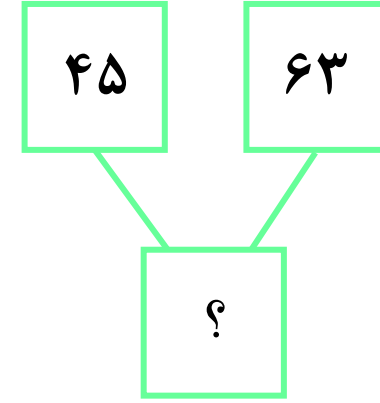

$4+5=9$

$6+3=9$

- ۳ ۱
- ۶ ۲
- ۹ ۳
- ۱۲ ۴



هوش ریاضی

در خانه به شکل اول گیرنده

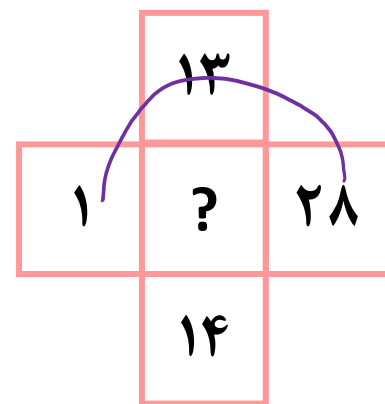
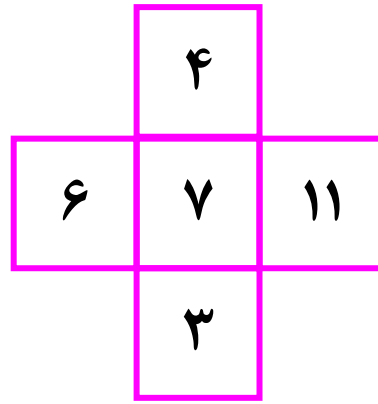
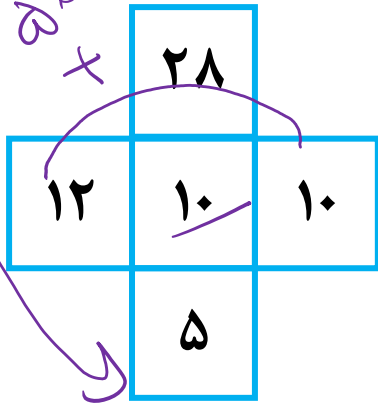
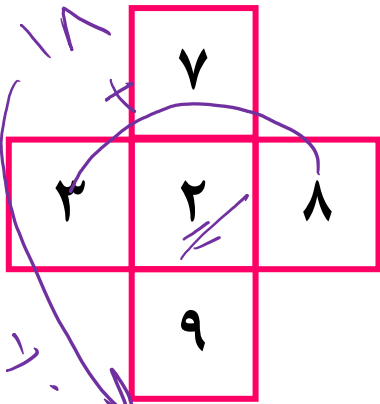

مقدار علامت سوال کدام است؟

- ۱
- ۲
- ۳
- ۴

$$1 + 12 + 28 = 41$$

$$\frac{41}{13} = 3$$





هوش ریاضی

تست

مقدار علامت سوال کدام است؟

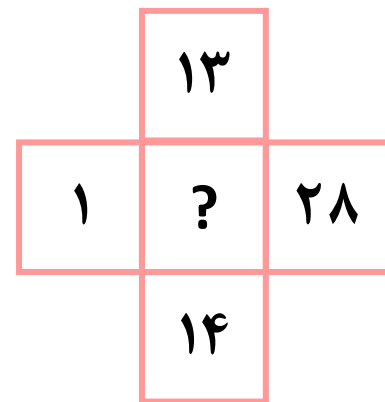
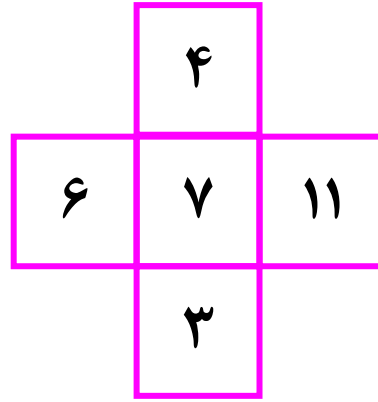
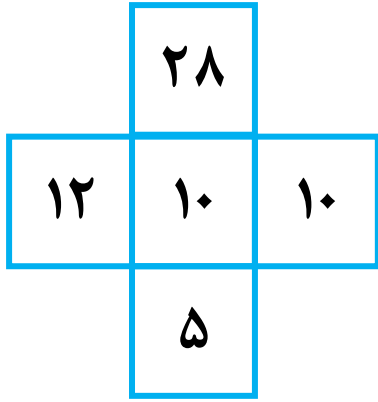
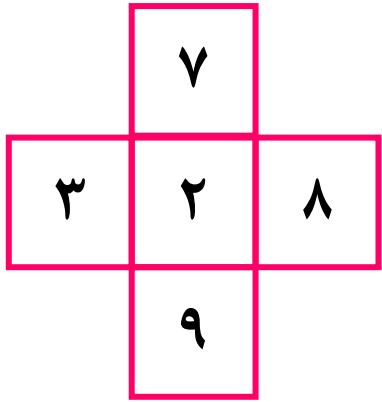

- ۱
- ۲
- ۳
- ۴

$$\frac{3 + 7 + 8}{9} = 2$$

$$\frac{12 + 28 + 10}{5} = 10$$

$$\frac{6 + 4 + 11}{3} = 7$$

$$\frac{1 + 13 + 28}{14} = 3$$



هوش ریاضی

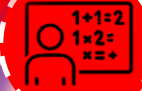

$$2 + 4 + 9 + 5 = 20$$

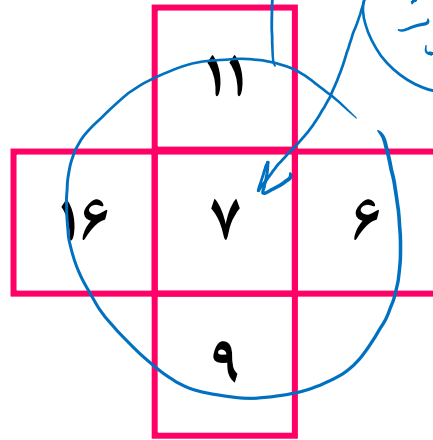
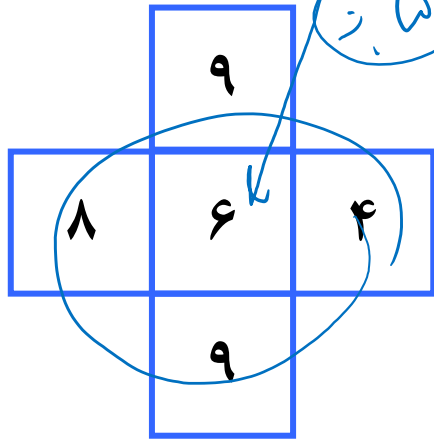
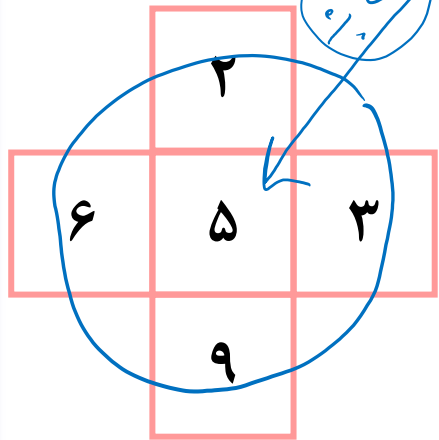

مقدار علامت سوال کدام است؟

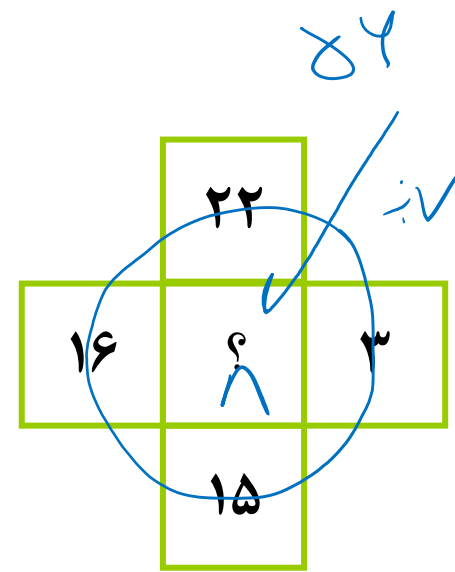

- ۱
- ۲
- ۳
- ۴



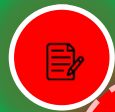

هوش ریاضی

تست

مقدار علامت سوال کدام است؟

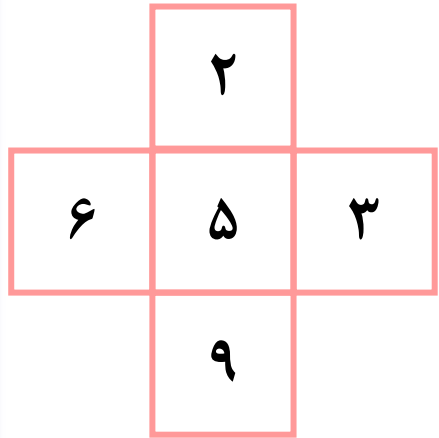

$$6 + 2 + 3 + 9 + 5 = 5 \times 5$$

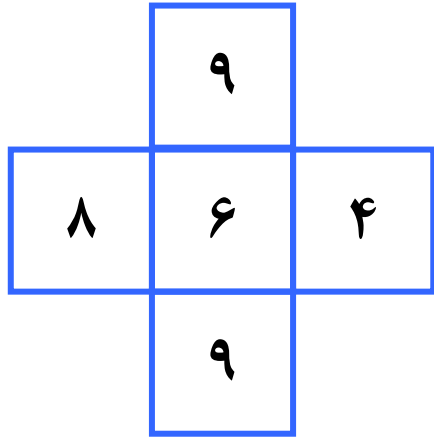

$$8 + 9 + 4 + 9 + 6 = 6 \times 6$$

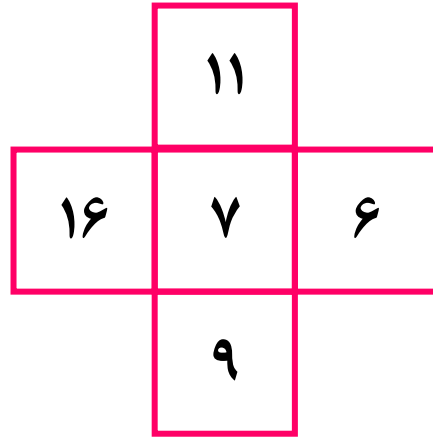

$$16 + 11 + 6 + 9 + 7 = 7 \times 7$$

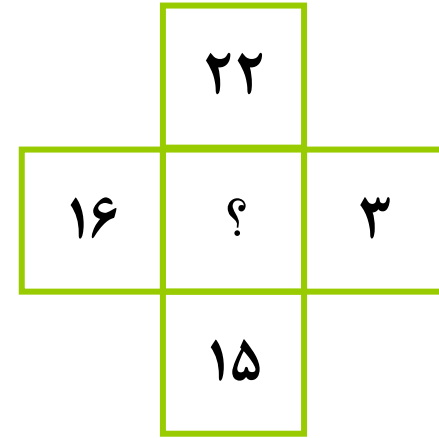

$$16 + 22 + 3 + 15 + ? = ? \times ?$$

۶ ۱

۸ ۲

۱۰ ۳

۱۲ ۴



هوش ریاضی



$$5 + 9 + 1 + 4 = 19$$

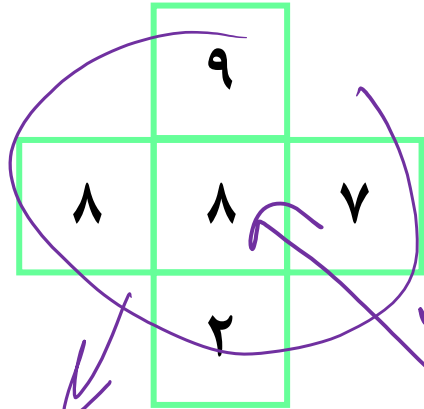
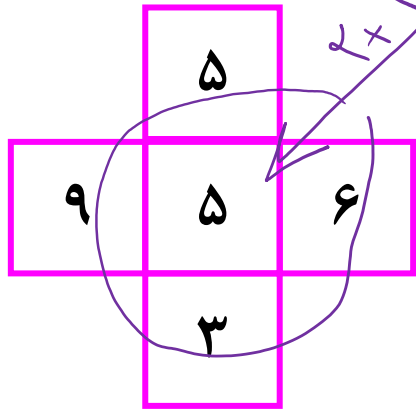

$$9 + 8 + 1 + 7 = 25$$

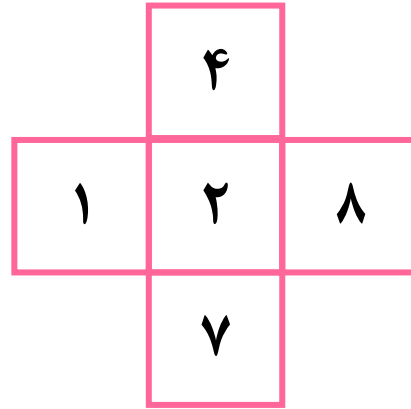

مقدار علامت سوال کدام است؟

$$2 + 4 + 9 + 3 = 18$$

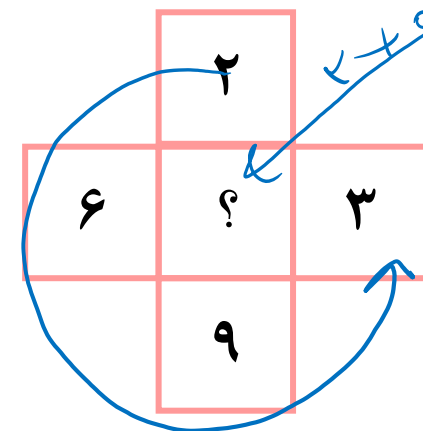

- ۱
- ۲
- ۳
- ۴
- ۶



مقدار علامت سوال کدام است؟

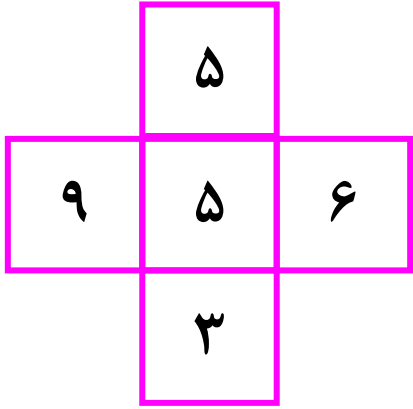

$$9 + 5 + 6 + 3 = 23$$

$$2 + 3 = 5$$

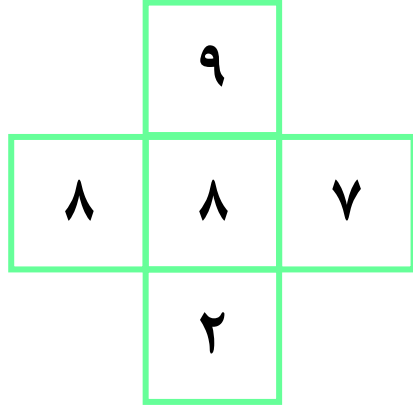

$$8 + 9 + 7 + 2 = 26$$

$$2 + 6 = 8$$

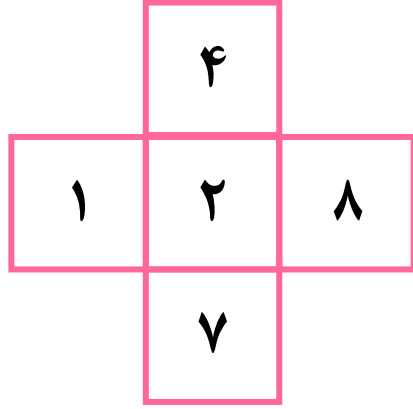

$$1 + 4 + 8 + 7 = 20$$

$$2 + 0 = 2$$

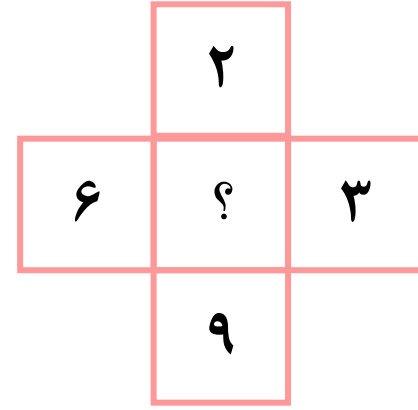

$$6 + 2 + 3 + 9 = 20$$

$$2 + 0 = 0$$

- ۸
- ۶
- ۴
- ۲



مقدار علامت سوال کدام است؟

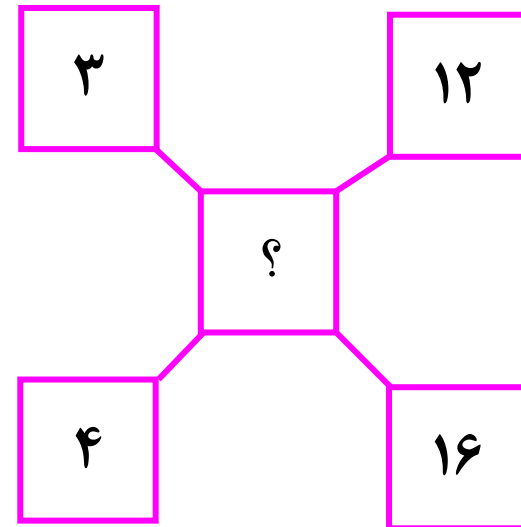
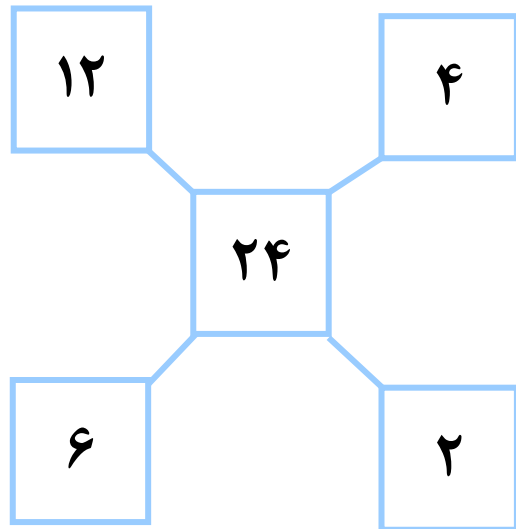
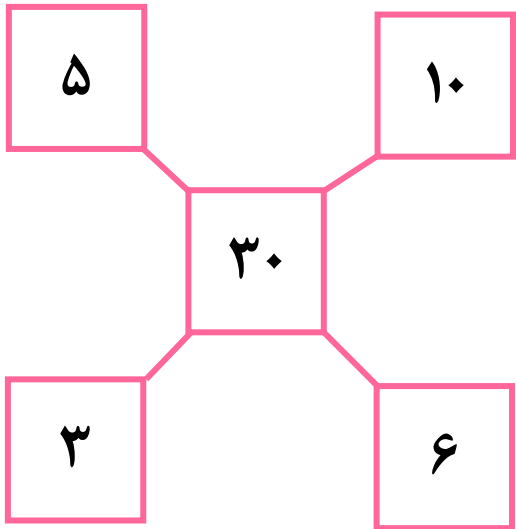

- 40 1
- 42 2
- 46 3
- 48 4



مقدار علامت سوال کدام است؟

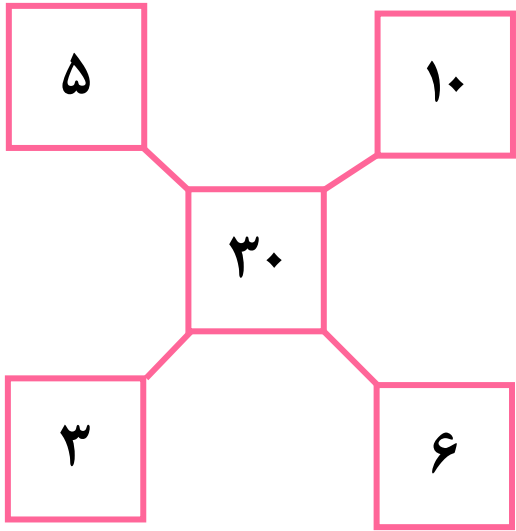

$$5 \times 6 = 30$$

$$3 \times 10 = 30$$

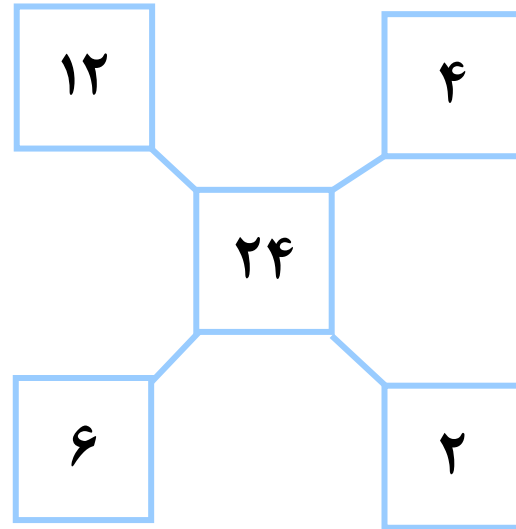

$$12 \times 2 = 24$$

$$6 \times 4 = 24$$

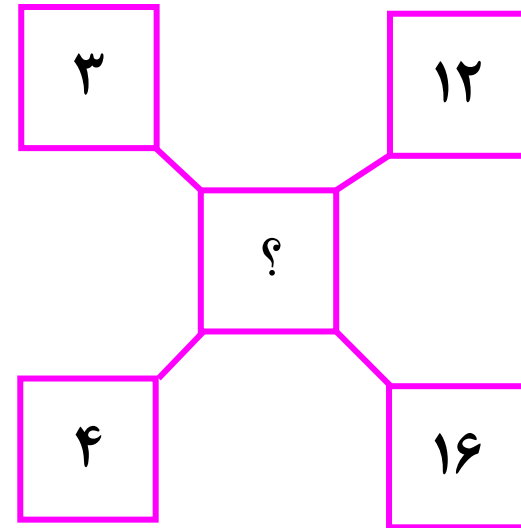

$$3 \times 16 = 48$$

$$4 \times 12 = 48$$

- ۴۰ ۱
- ۴۲ ۲
- ۴۶ ۳
- ۴۸ ۴



تست

مقدار علامت سوال کدام است؟

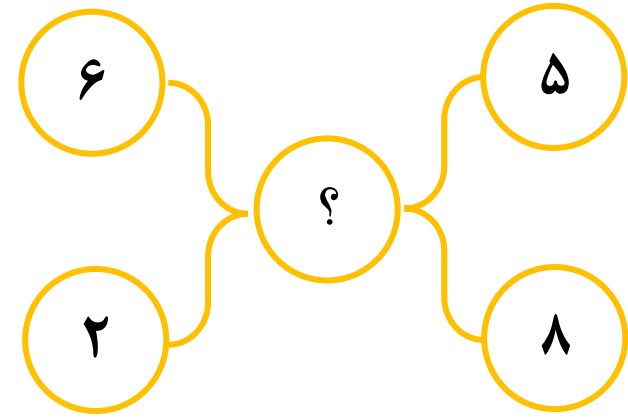
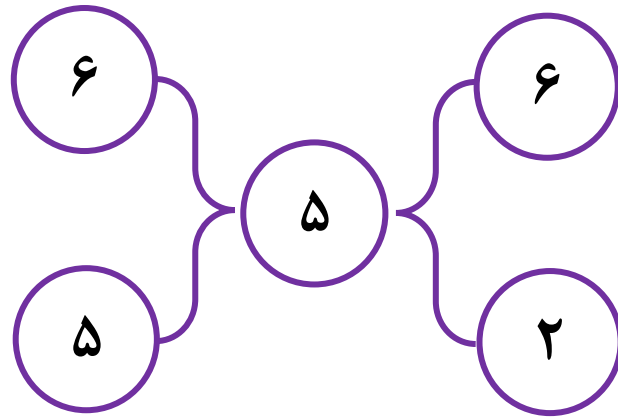
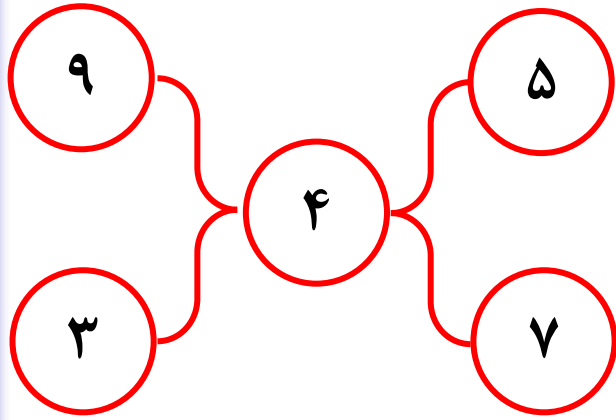

- ۱
- ۲
- ۳
- ۴

هوش ریاضی



هوشاند

موسسه تخصصی هوش





هوش ریاضی

تست

مقدار علامت سوال کدام است؟

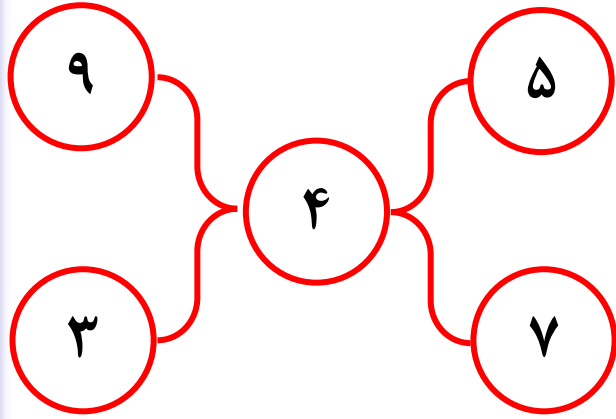

$$(9+5) - (3+7) = 4$$

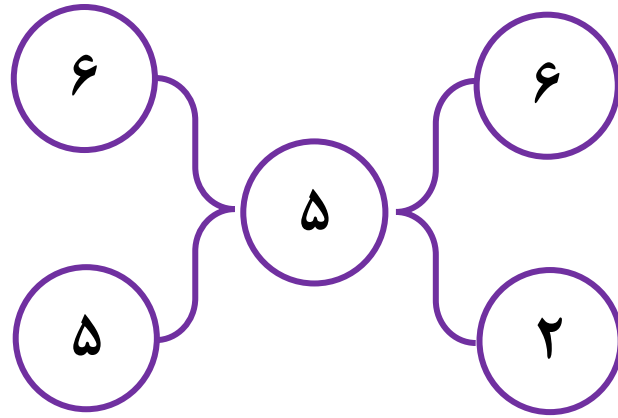

$$(6+6) - (5+2) = 5$$

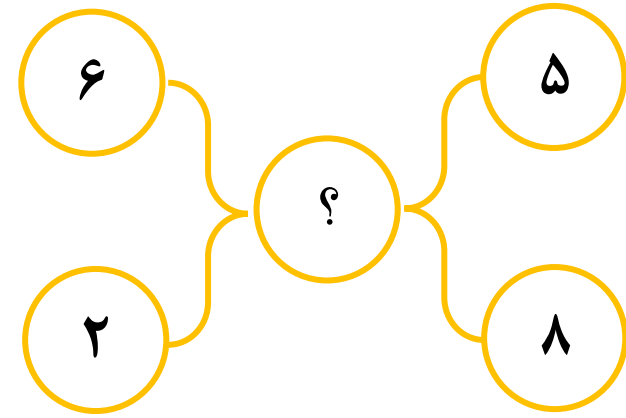

$$(6+5) - (2+8) = 1$$

۱

۲

۳

۴





هوش ریاضی

تست

مقدار علامت سوال کدام است؟

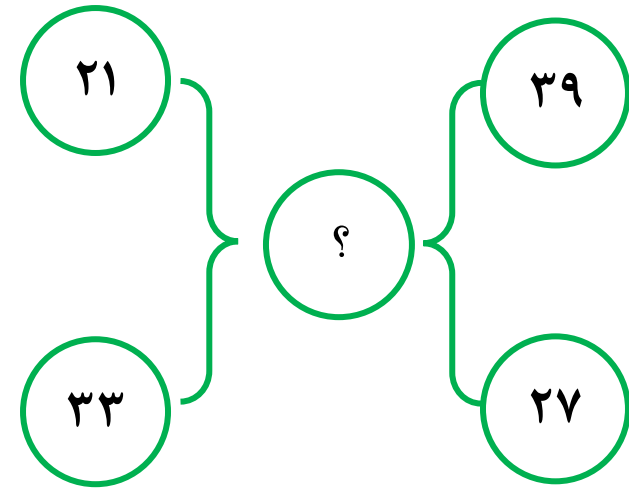
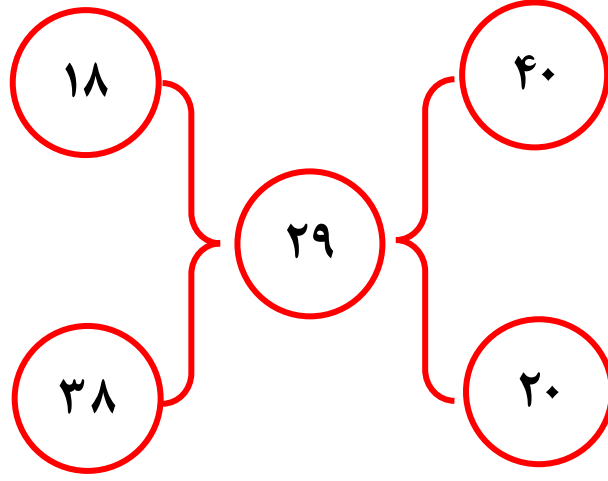
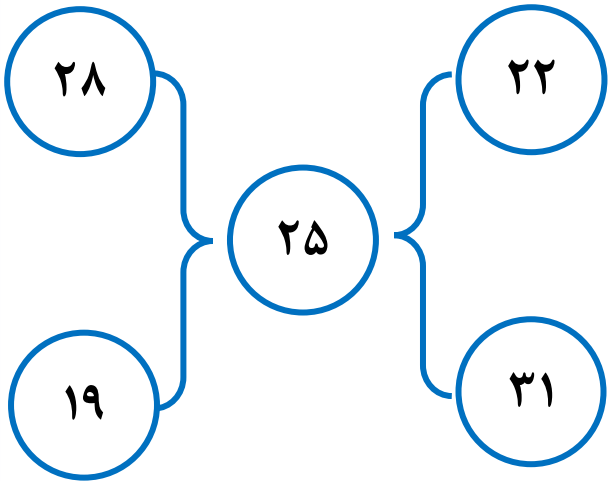

- ۱۰ ۱
- ۲۰ ۲
- ۳۰ ۳
- ۴۰ ۴





هوش ریاضی

تست

مقدار علامت سوال کدام است؟

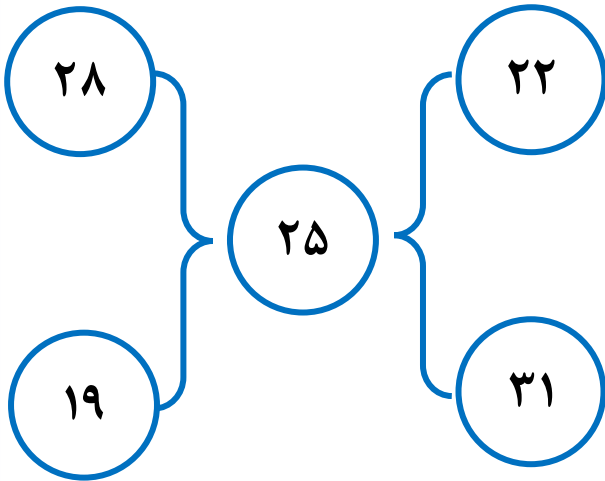

$$28 + 22 = 50$$

$$19 + 31 = 50$$

$$\frac{50}{2} = 25$$

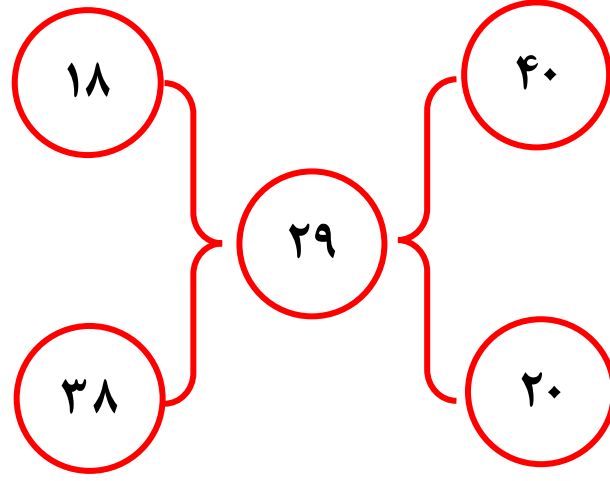

$$18 + 40 = 58$$

$$38 + 20 = 58$$

$$\frac{58}{2} = 29$$

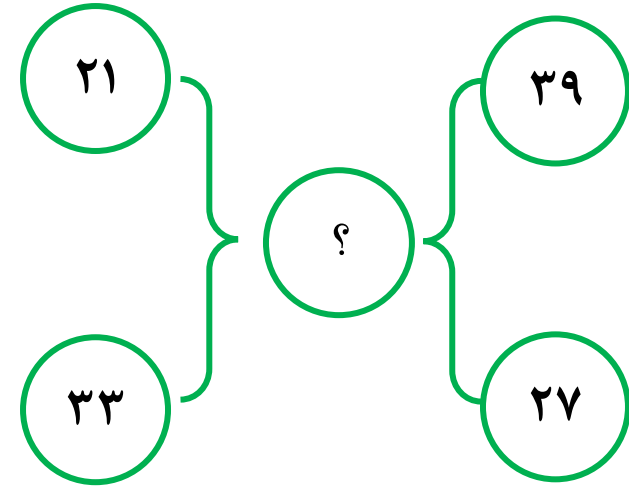

$$21 + 39 = 60$$

$$33 + 27 = 60$$

$$\frac{60}{2} = 30$$

- ۱۰ ۱
- ۲۰ ۲
- ۳۰ ۳
- ۴۰ ۴





هوش ریاضی

تست

مقدار علامت سوال کدام است؟

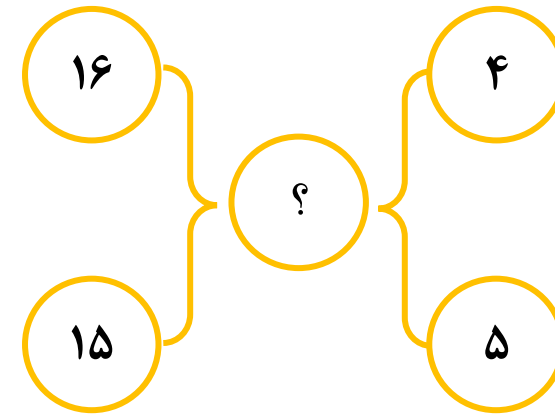
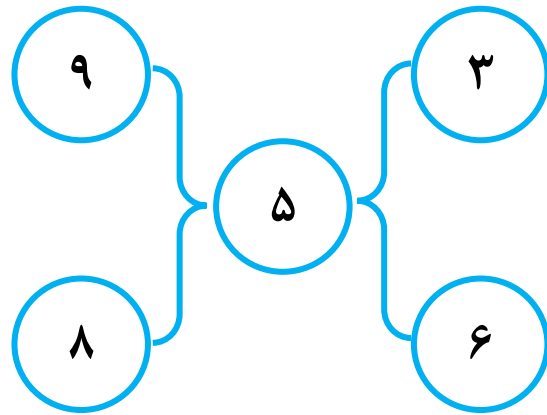
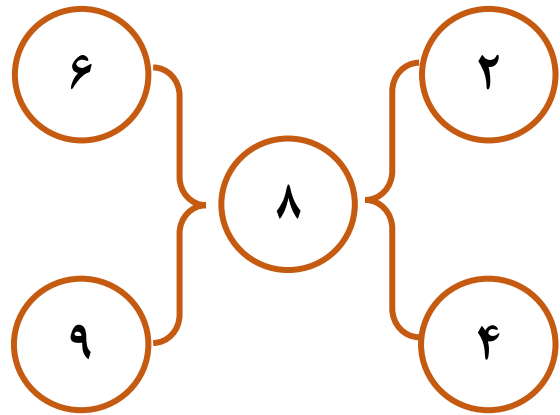

۱۲ ۱

۱۴ ۲

۱۶ ۳

۱۸ ۴



هوشلند

www.hushland.com





هوش ریاضی

تست

مقدار علامت سوال کدام است؟

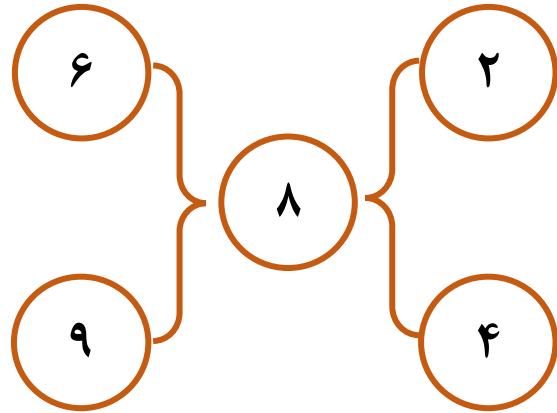

$$(6 \div 2) + (9 - 4) = 4$$

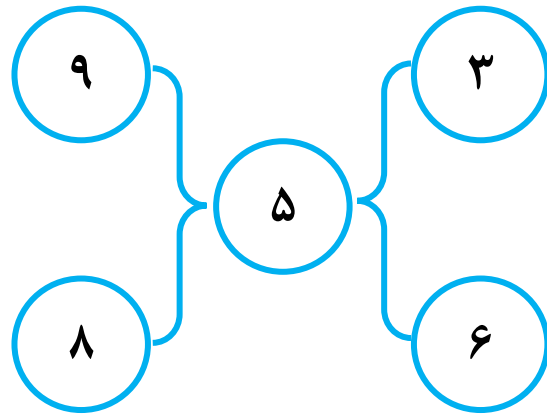

$$(9 \div 3) + (8 - 6) = 5$$

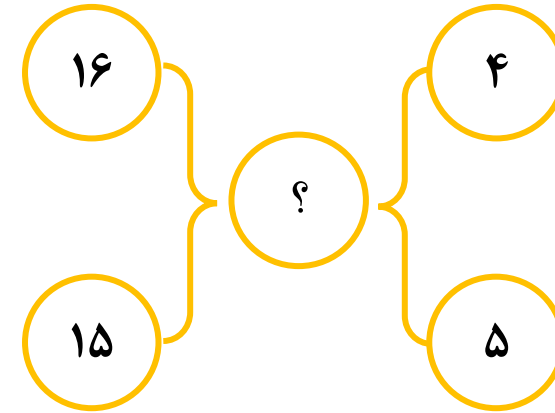

$$(16 \div 4) + (15 - 5) = 4$$

- ۱۲
- ۱۴
- ۱۶
- ۱۸



مقدار علامت سوال کدام است؟

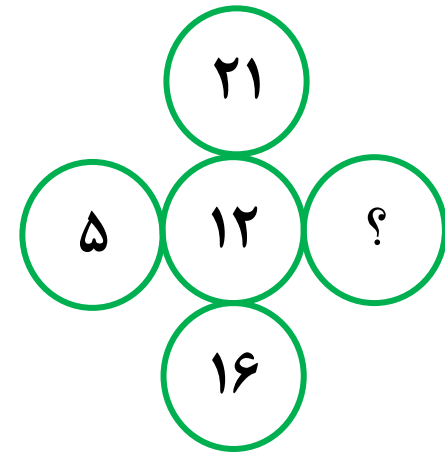
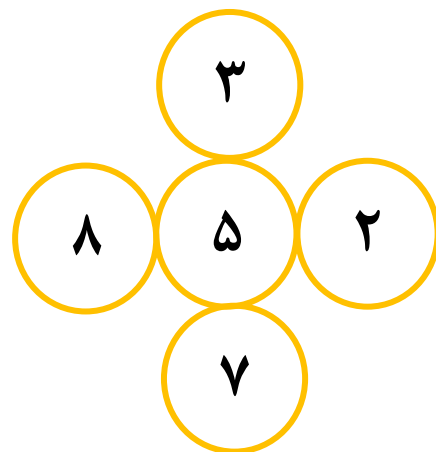
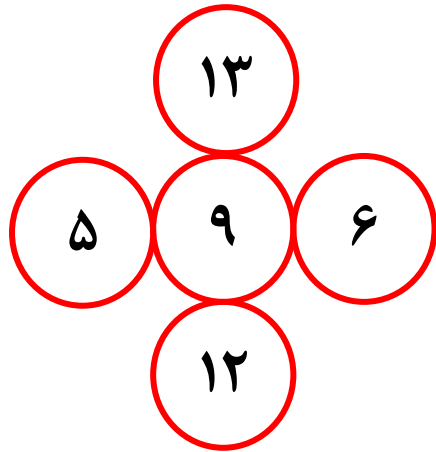
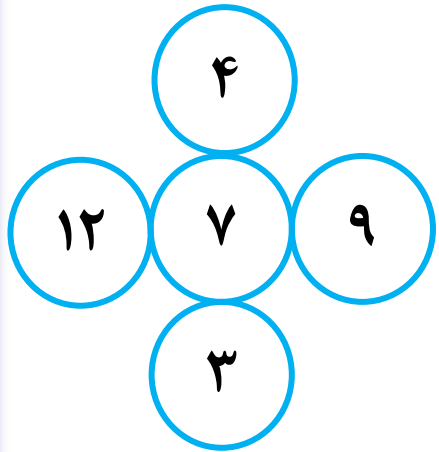

- ۱
 - ۲
 - ۳
 - ۴
- ۶
۹
۵
۱۱



مقدار علامت سوال کدام است؟

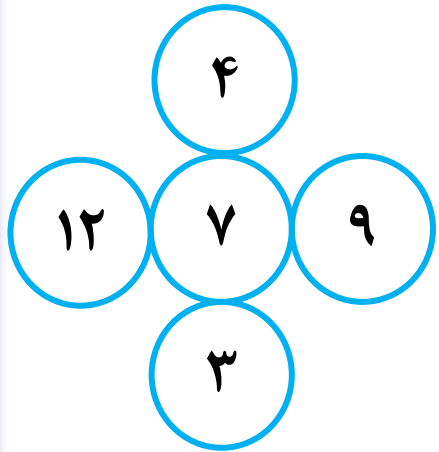

$$\frac{12 + 4 + 9 + 3}{4} = 7$$

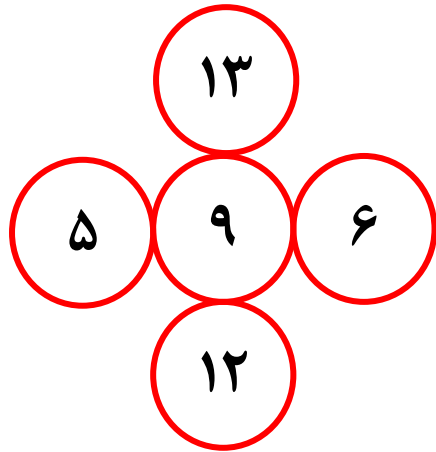

$$\frac{5 + 13 + 6 + 12}{4} = 9$$

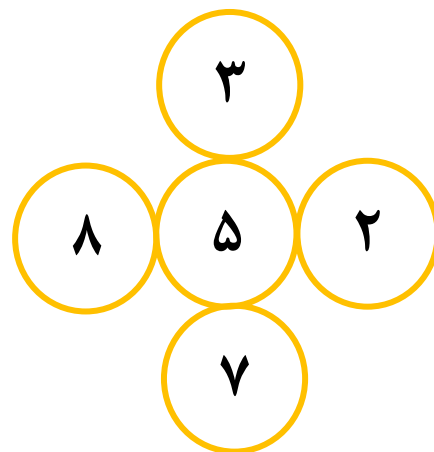

$$\frac{8 + 3 + 2 + 7}{4} = 5$$

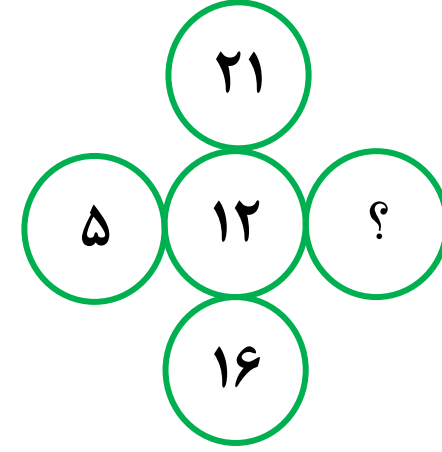

$$\frac{5 + 21 + ? + 16}{4} = 12$$

- ۶ ۱
- ۹ ۲
- ۵ ۳
- ۱۱ ۴

مقدار علامت سوال کدام است؟

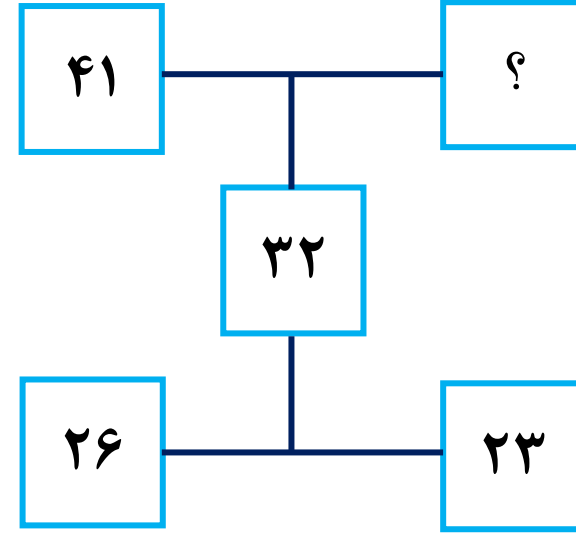
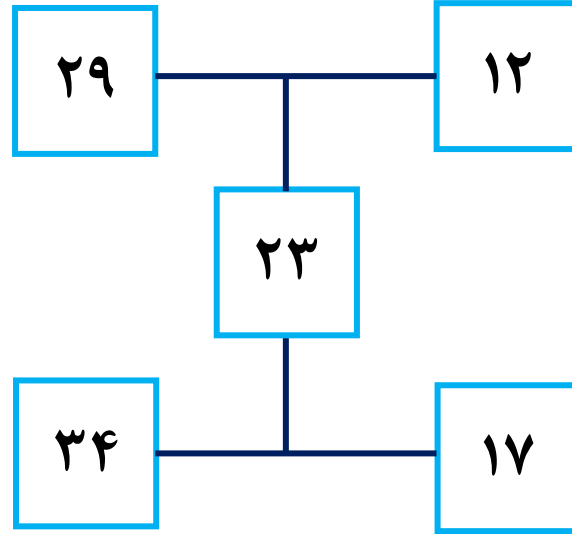
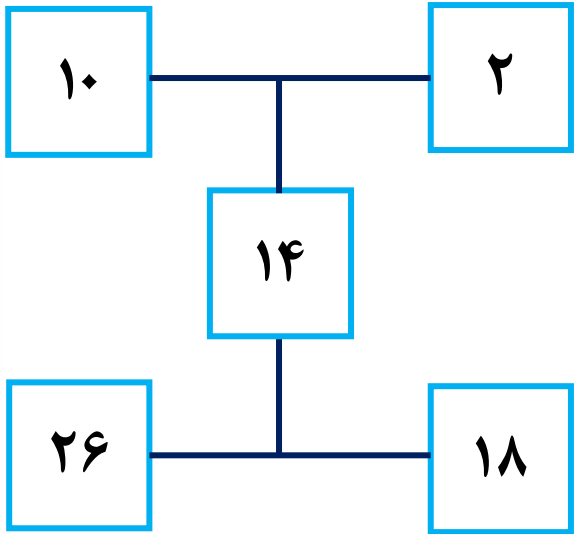

- ۳۸ ۱
- ۳۵ ۲
- ۳۱ ۳
- ۲۲ ۴





هوش ریاضی

تست

مقدار علامت سوال کدام است؟

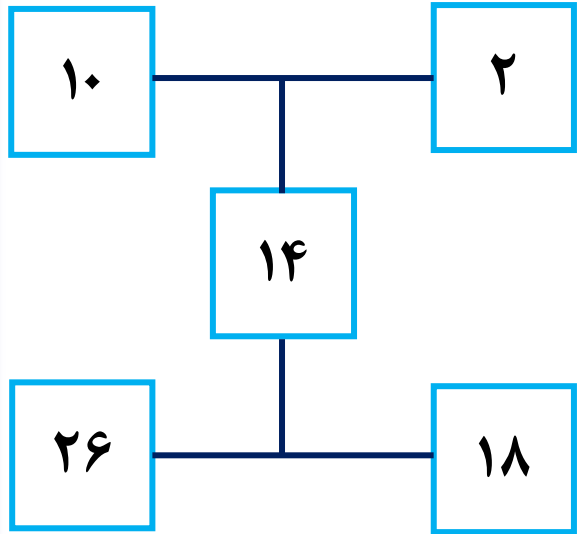

$$14 - 10 = 4 = 18 - 14$$

$$26 - 14 = 12 = 14 - 2$$

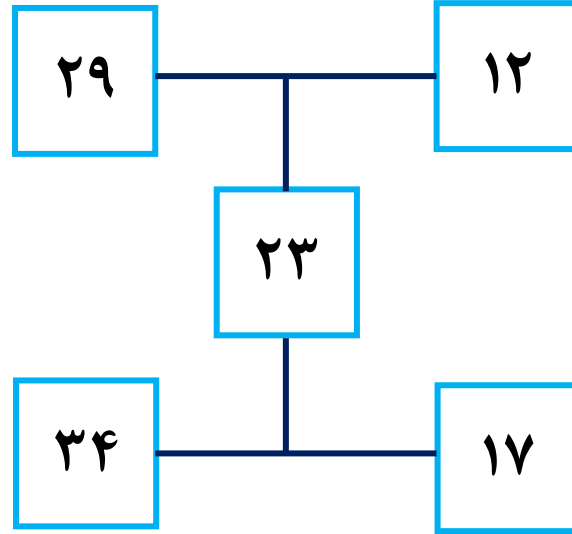

$$29 - 23 = 6 = 23 - 17$$

$$34 - 23 = 11 = 23 - 12$$

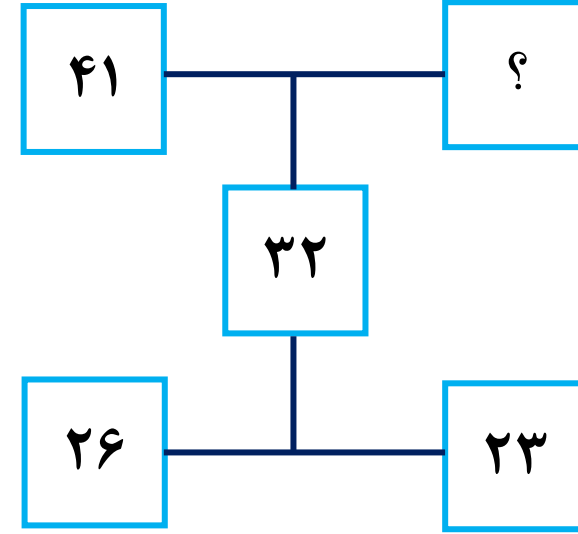

$$41 - 32 = 9 = 32 - 23$$

$$32 - 26 = 6 = ? - 23$$

- 38 1
- 35 2
- 31 3
- 22 4



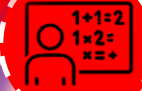

هوش ریاضی

تست

مقدار علامت سوال کدام است؟

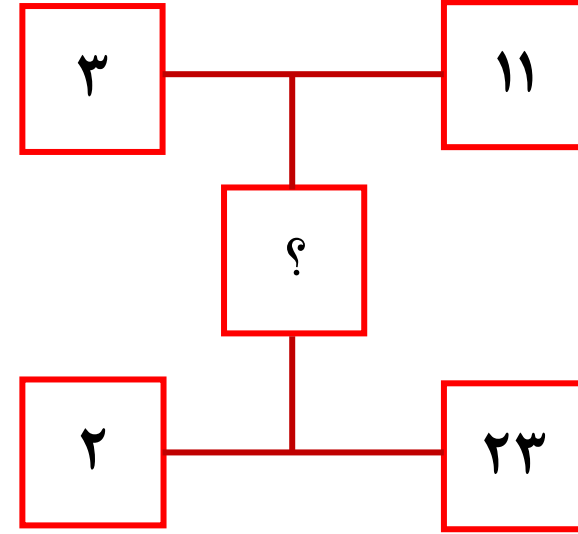
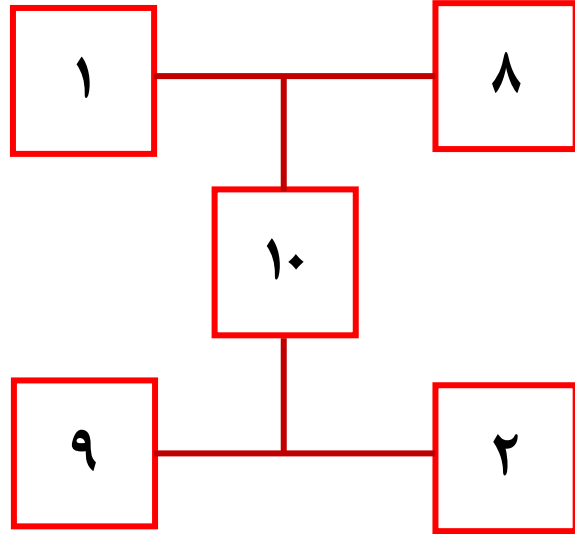
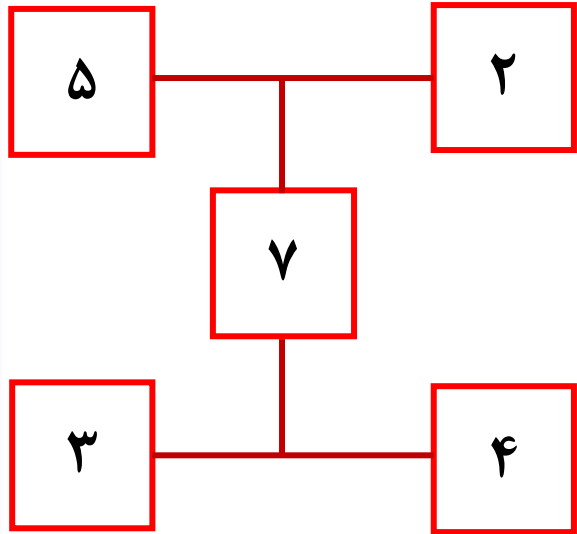

- ۱۰ ۱
- ۱۱ ۲
- ۱۳ ۳
- ۱۴ ۴



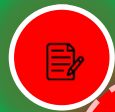

هوش ریاضی

تست

مقدار علامت سوال کدام است؟

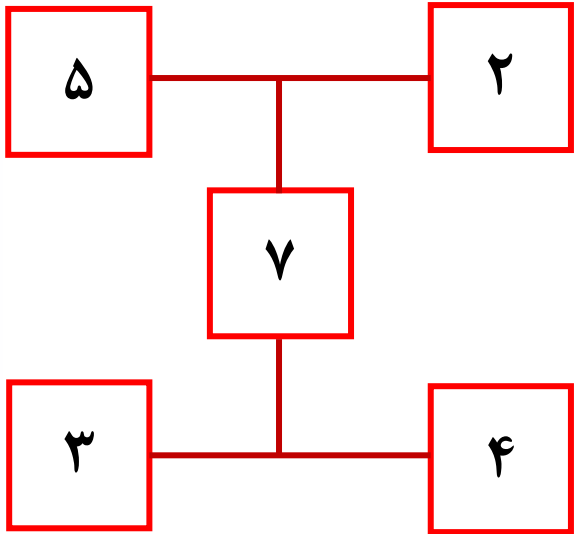

$$\frac{5+2+3+4}{2} = 7$$

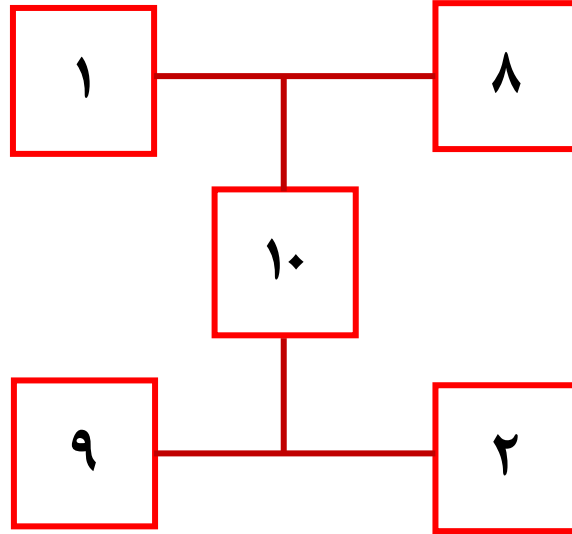

$$\frac{1+8+9+2}{2} = 10$$

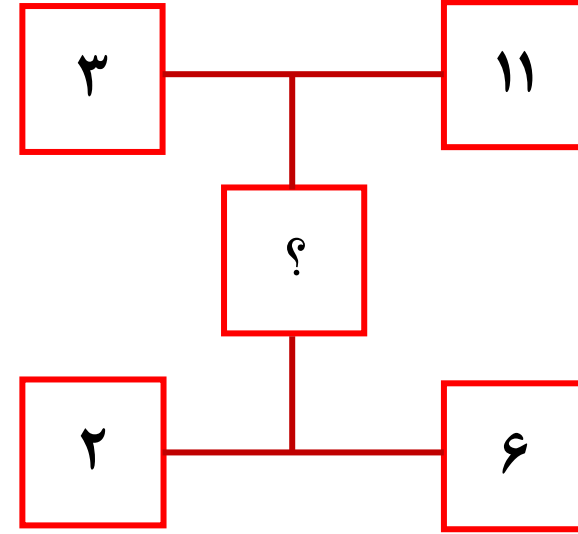

$$\frac{3+11+2+6}{2} = 11$$

- ۱۰ ۱
- ۱۱ ۲
- ۱۳ ۳
- ۱۴ ۴

