



هوش تصویری

تصویر متفاوت

تو این مدل سوالات ما می خوان گزینه ای که با بقیه فرق می کنه رو پیدا کنیم.

۱ تعداد و نوع اجزای شکل



۴ دوران



۲ ترتیب قرار گرفتن شکل ها



۵ جهت شکل و هاشور و فلش ها



۳ ترتیب قرار گرفتن شکل ها



۶ رابطه ی بین اجزای شکل





هوش تصویری

* تو با هم گزنی ما برتا شکل داخل
* یک راجع به اجزای شکل دهنده به در ضمن صوره

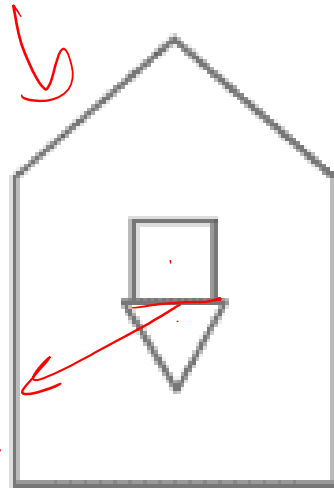

(۴)

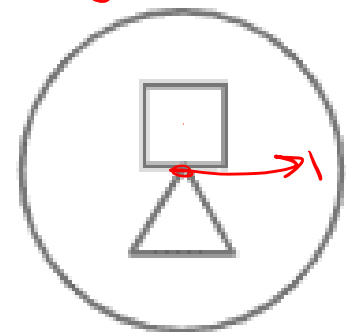

(۳)

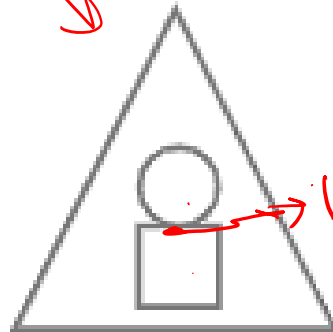

(۲)

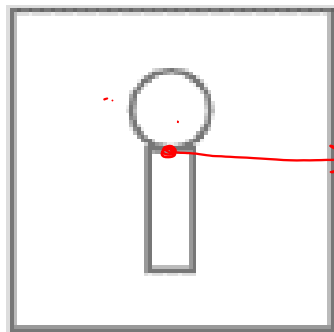

(۱)

بی مادر

* گزنی بر دهن

* تعداد نقاط بر خورد در شکل داخل





هوش تصویری

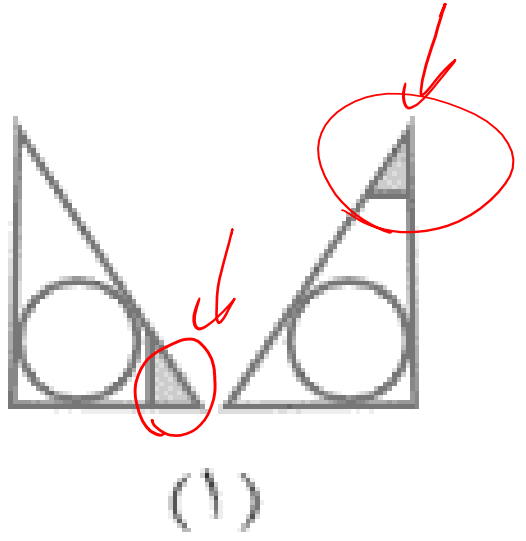
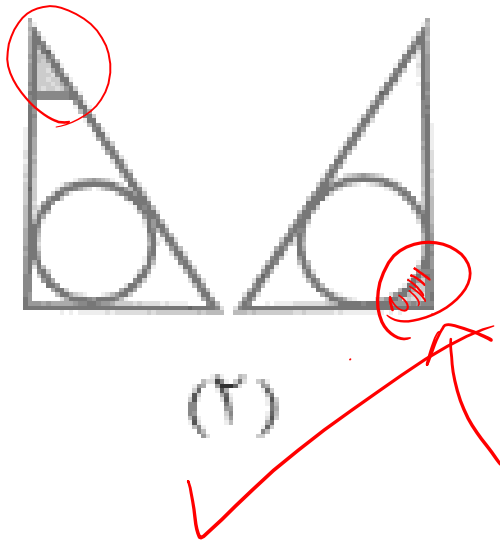
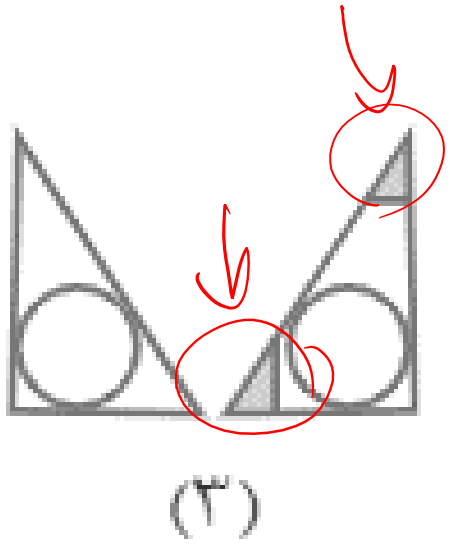
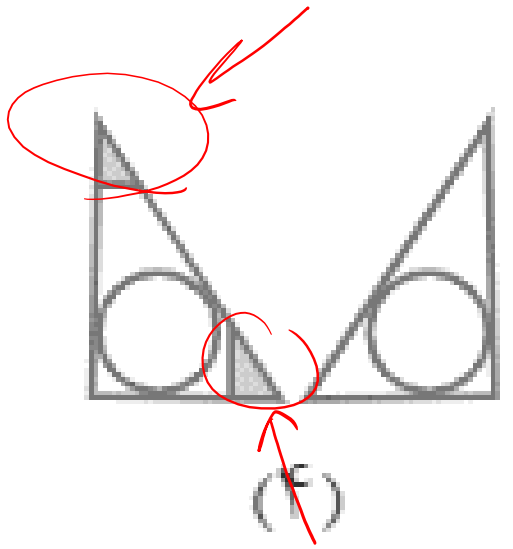



هوش تصویری

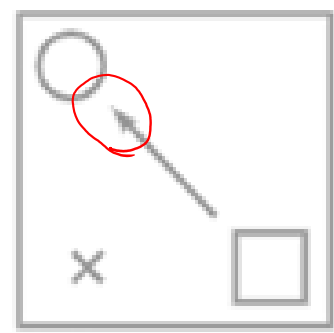

(۵)

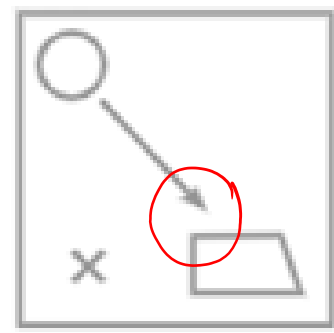

(۴)

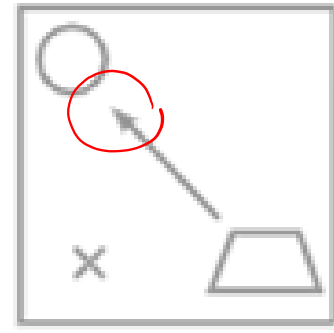

(۳)

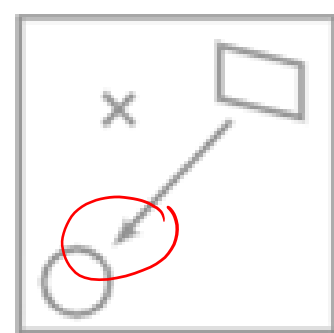

(۲)

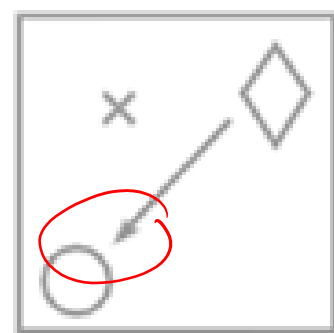

(۱)

هوش مناس از راه عقلی پیدا کرد





هوش تصویری

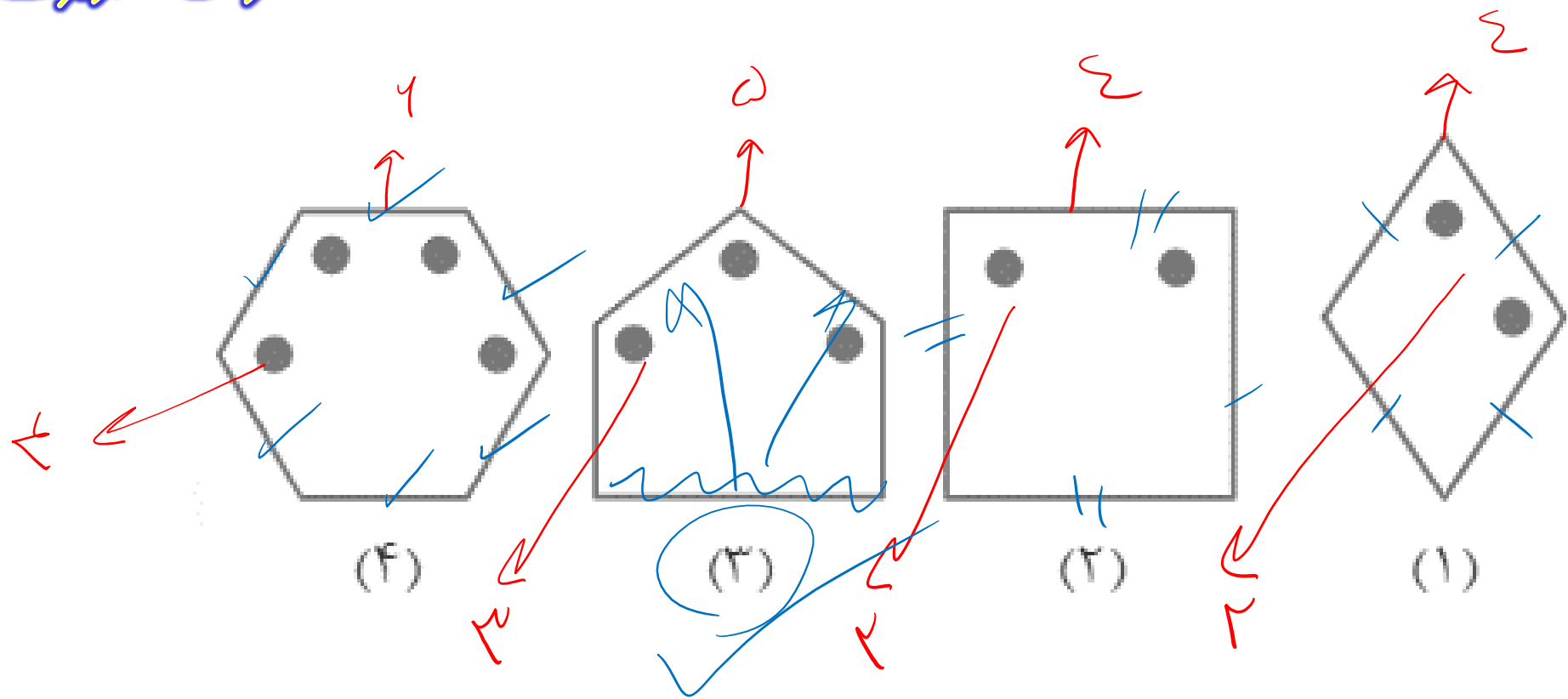



1+1=2
1x2=2
x=+

هوش تصویری

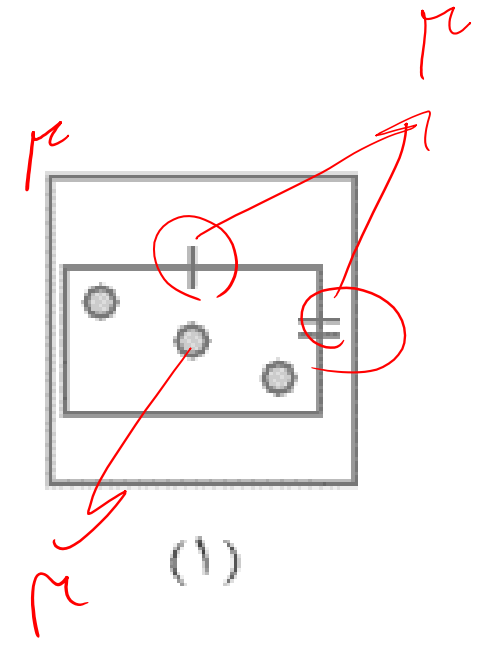
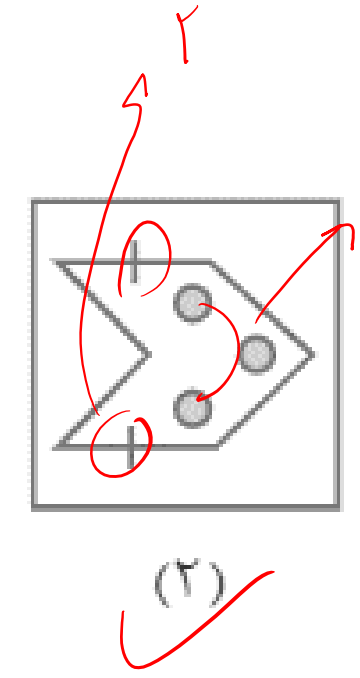
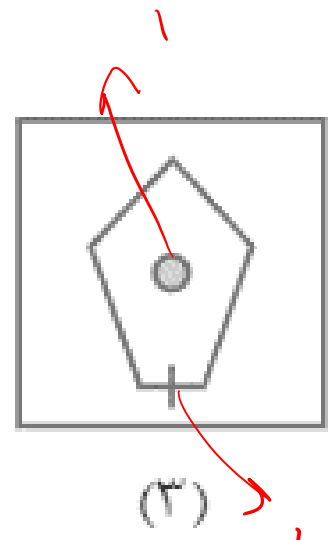
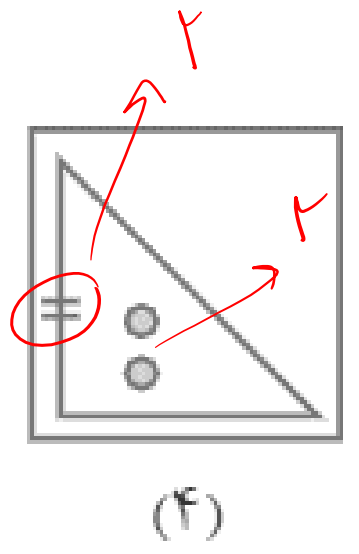
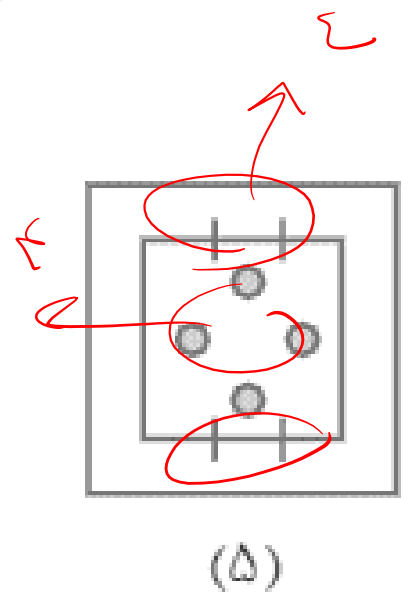



هوش تصویری

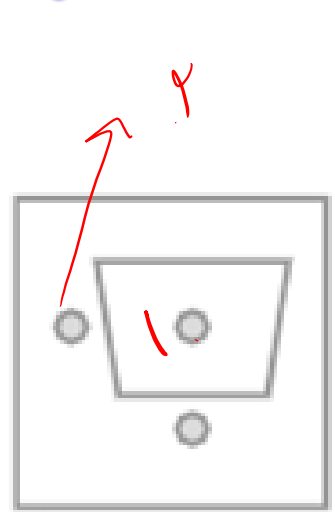

(۵)

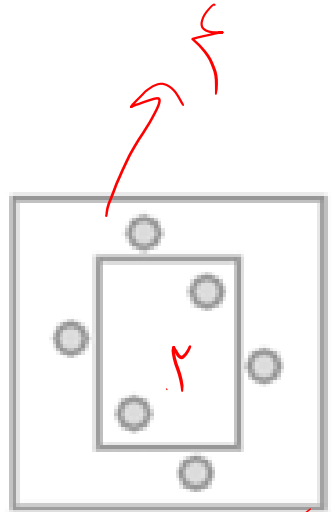

(۴)

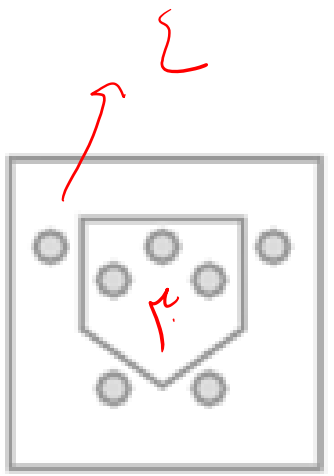
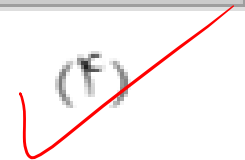

(۳)

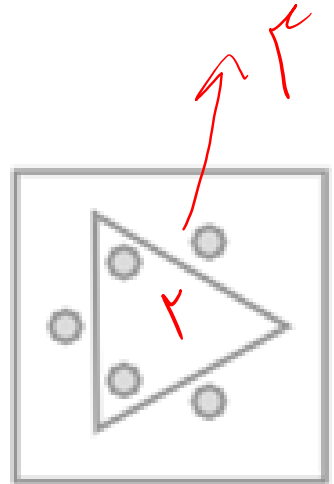

(۲)

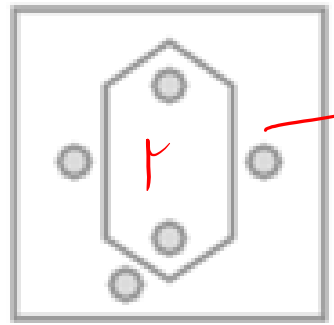

(۱)





هوش تصویری

1 ← ○ ● ○	2 ← ● ● ○	1 ← ● ○ ○	○ ● ○ → 1
2 ← ○ ● ●	1 ← ○ ○ ●	1 ← ○ ● ●	○ ● ● → 2
2 ← ● ○ ●	2 ← ● ○ ●	2 ← ● ○ ●	○ ● ● → 2
(4)	(3) ✓	(2)	(1)





هوش تصویری

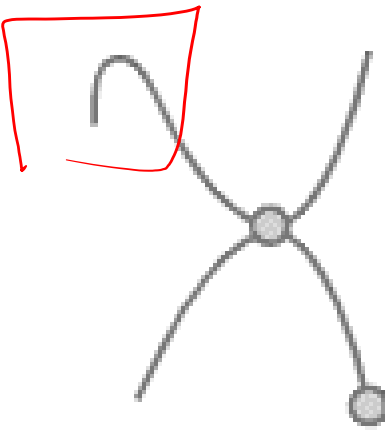

(۴)

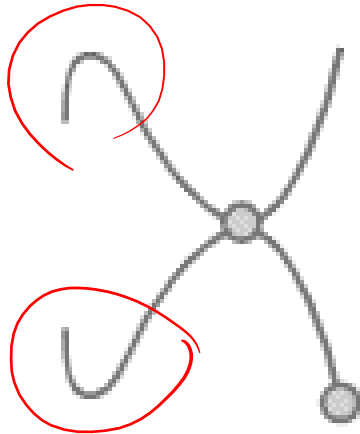
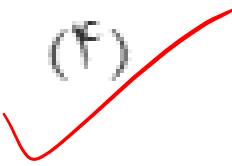

(۳)

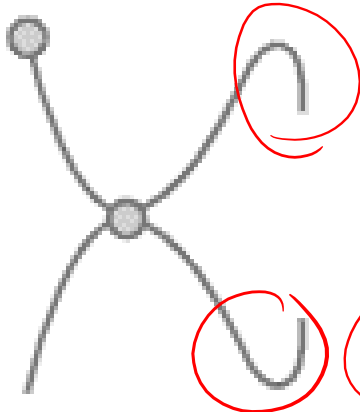

(۲)

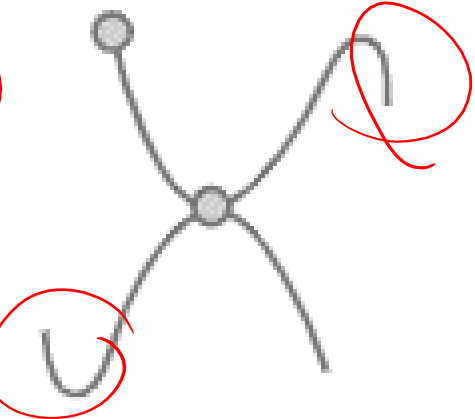

(۱)





هوش تصویری

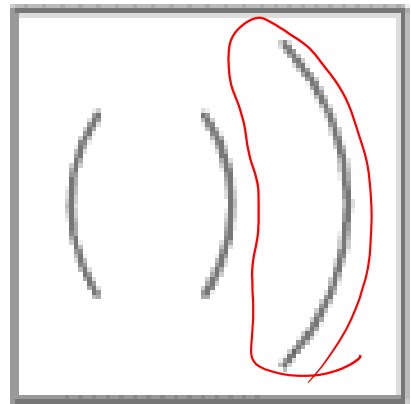

(۴)

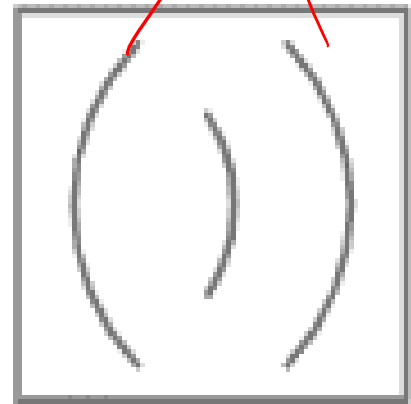
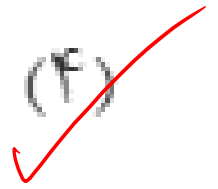

(۳)

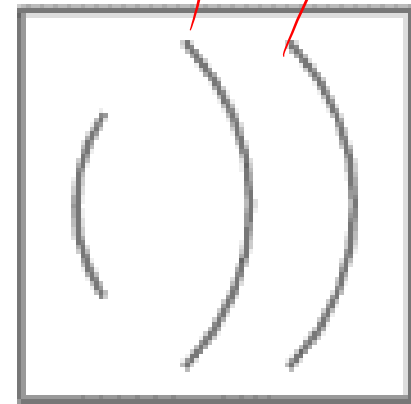

(۲)

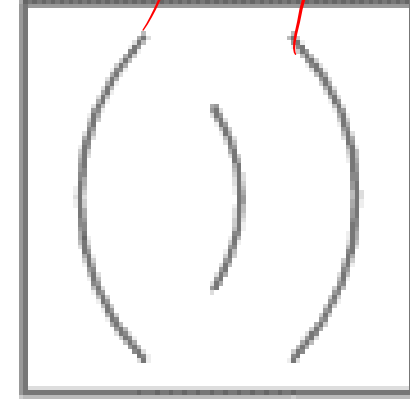

(۱)

اجزای شکل دهنده





هوش تصویری



(۴)

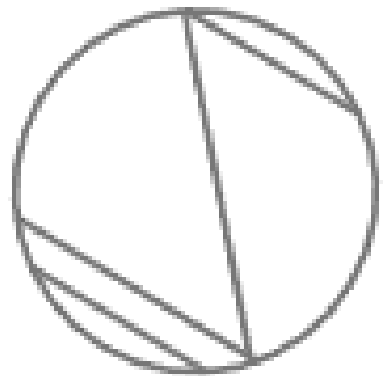

(۳)

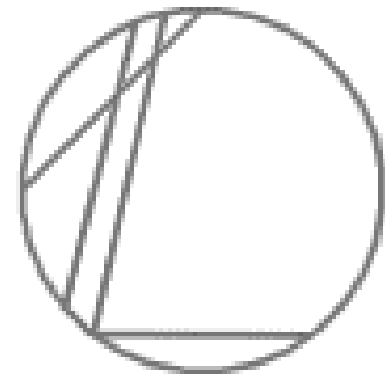

(۲)

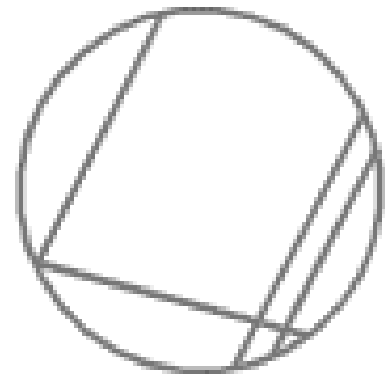

(۱)

۳ و ۱





هوش تصویری

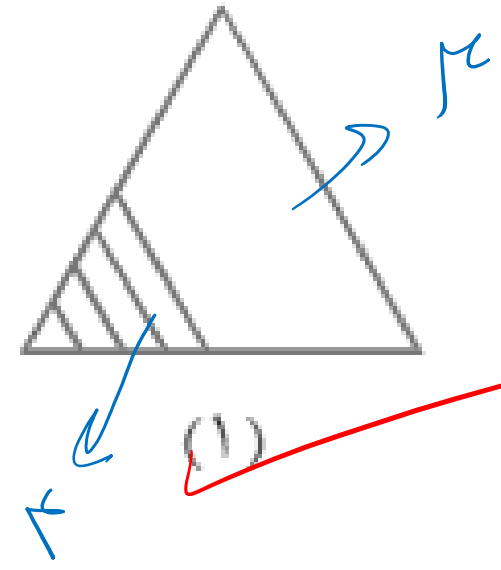
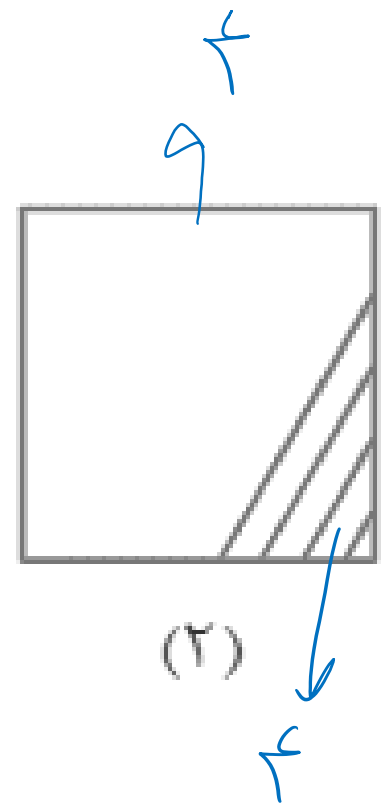
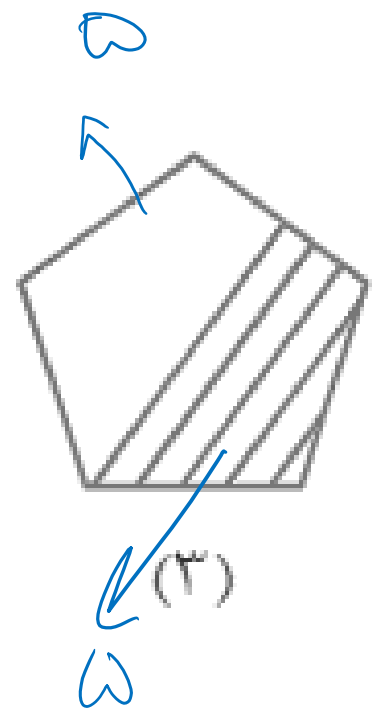
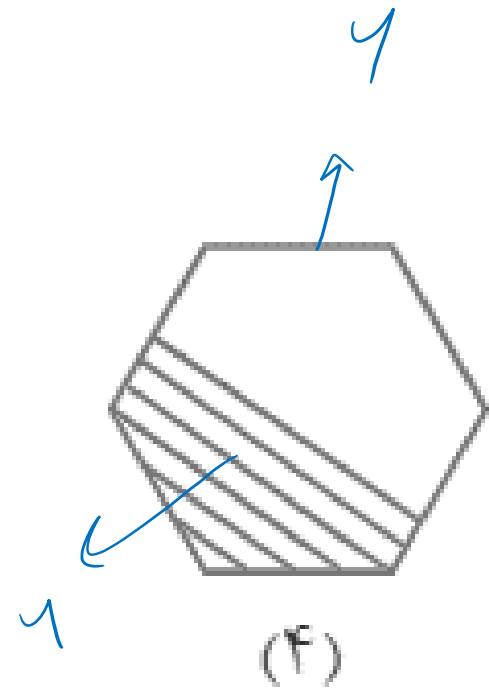



هوش تصویری

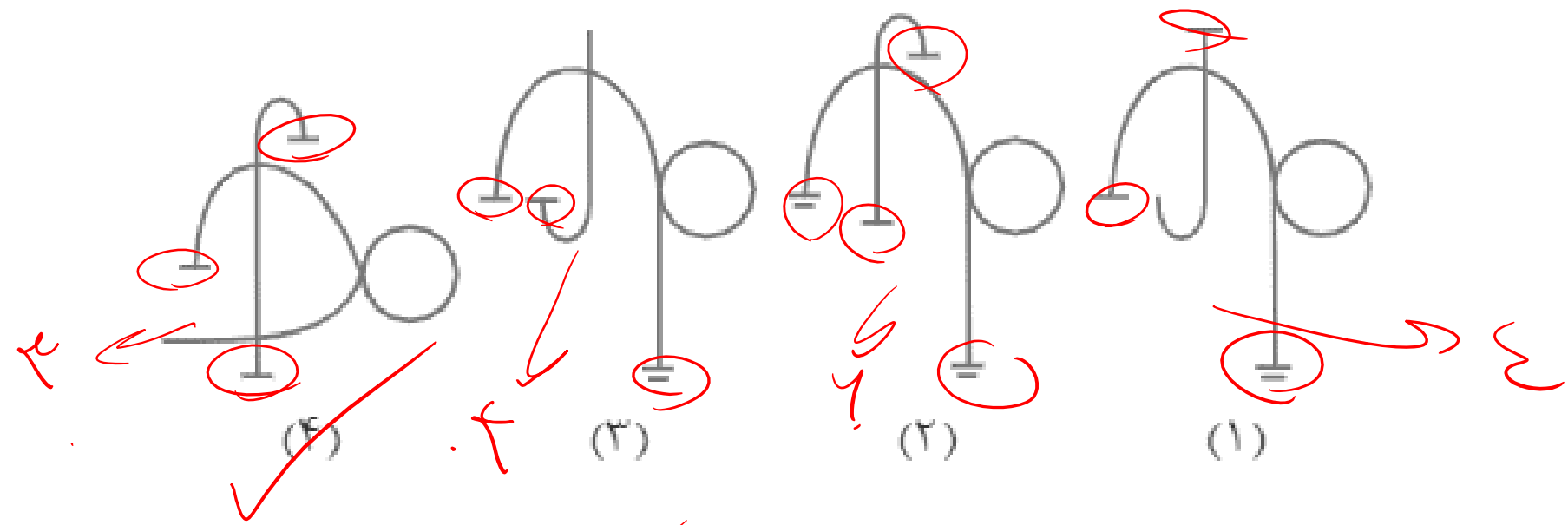

تعداد پاره‌های حال اردو لگو





هوش تصویری

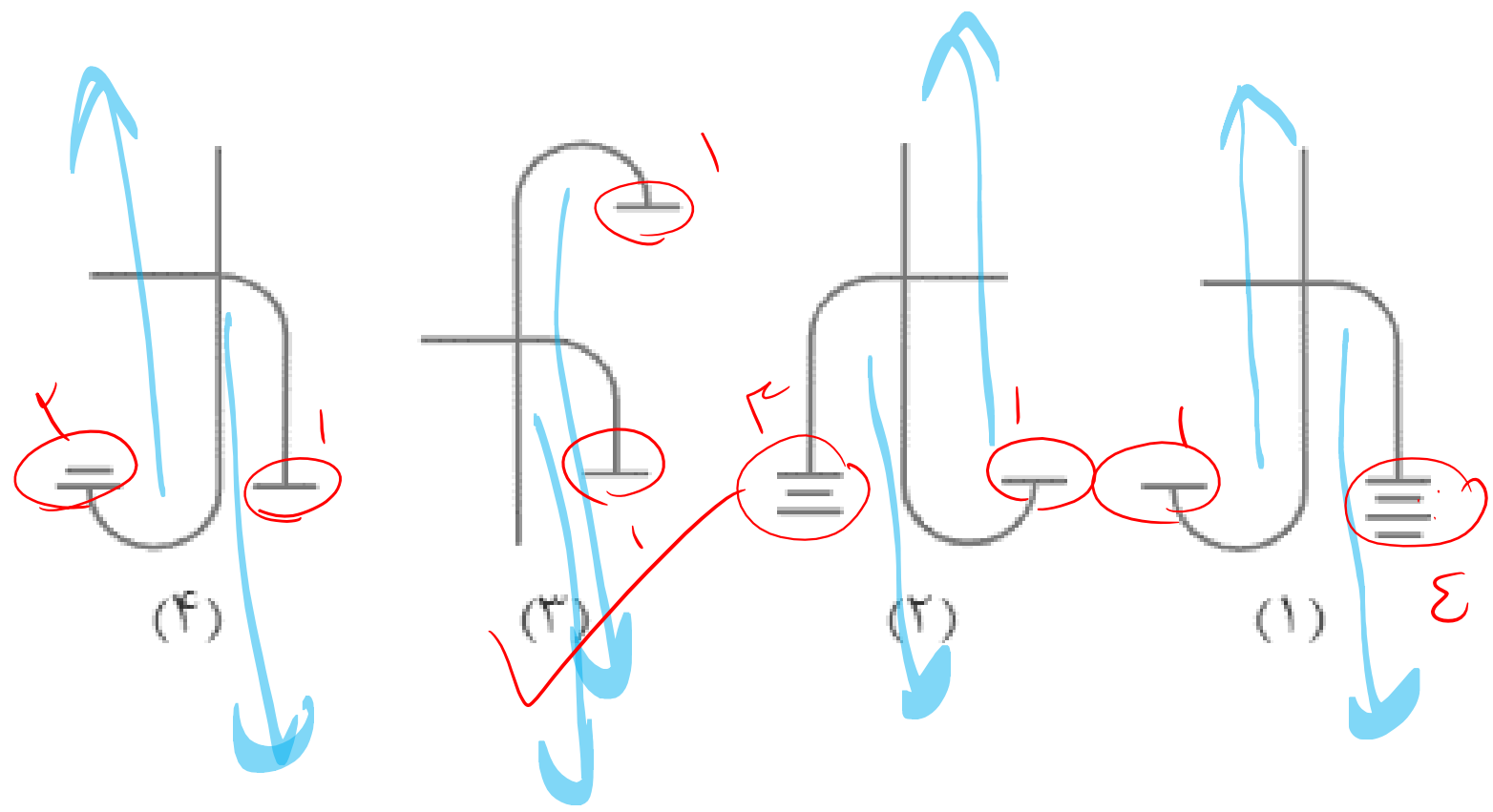



هوش تصویری

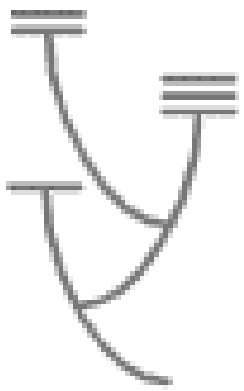

(A)

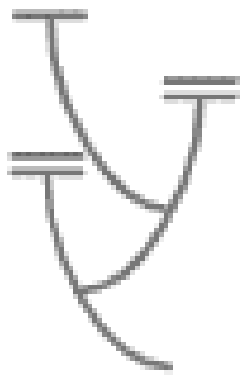

(B)

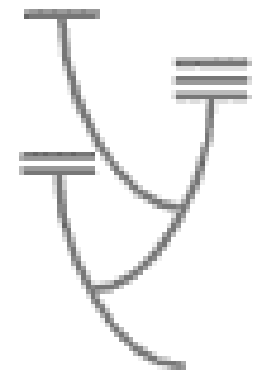

(C)



(D)

۲ ۳ ۴





هوش تصویری

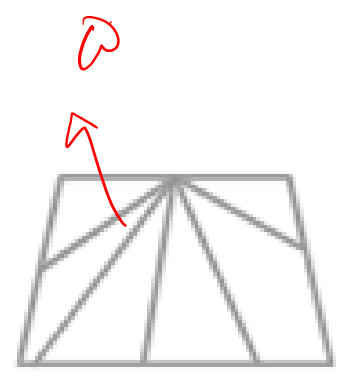

(۴)

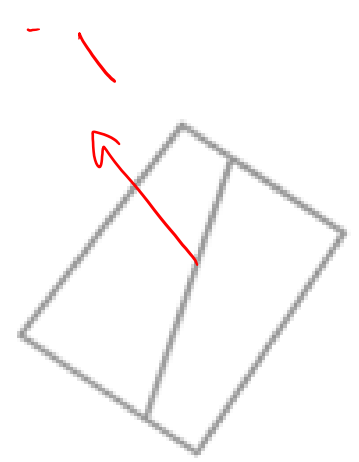

(۳)

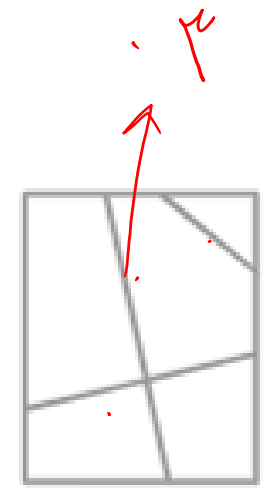

(۲)

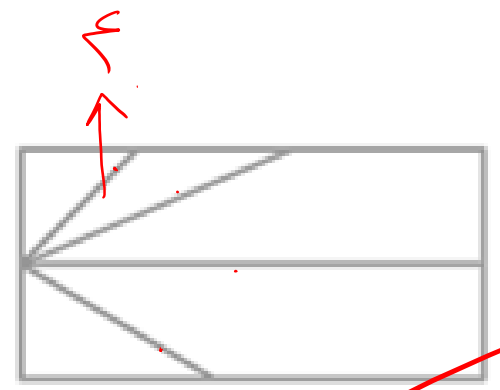

(۱)





هوش تصویری

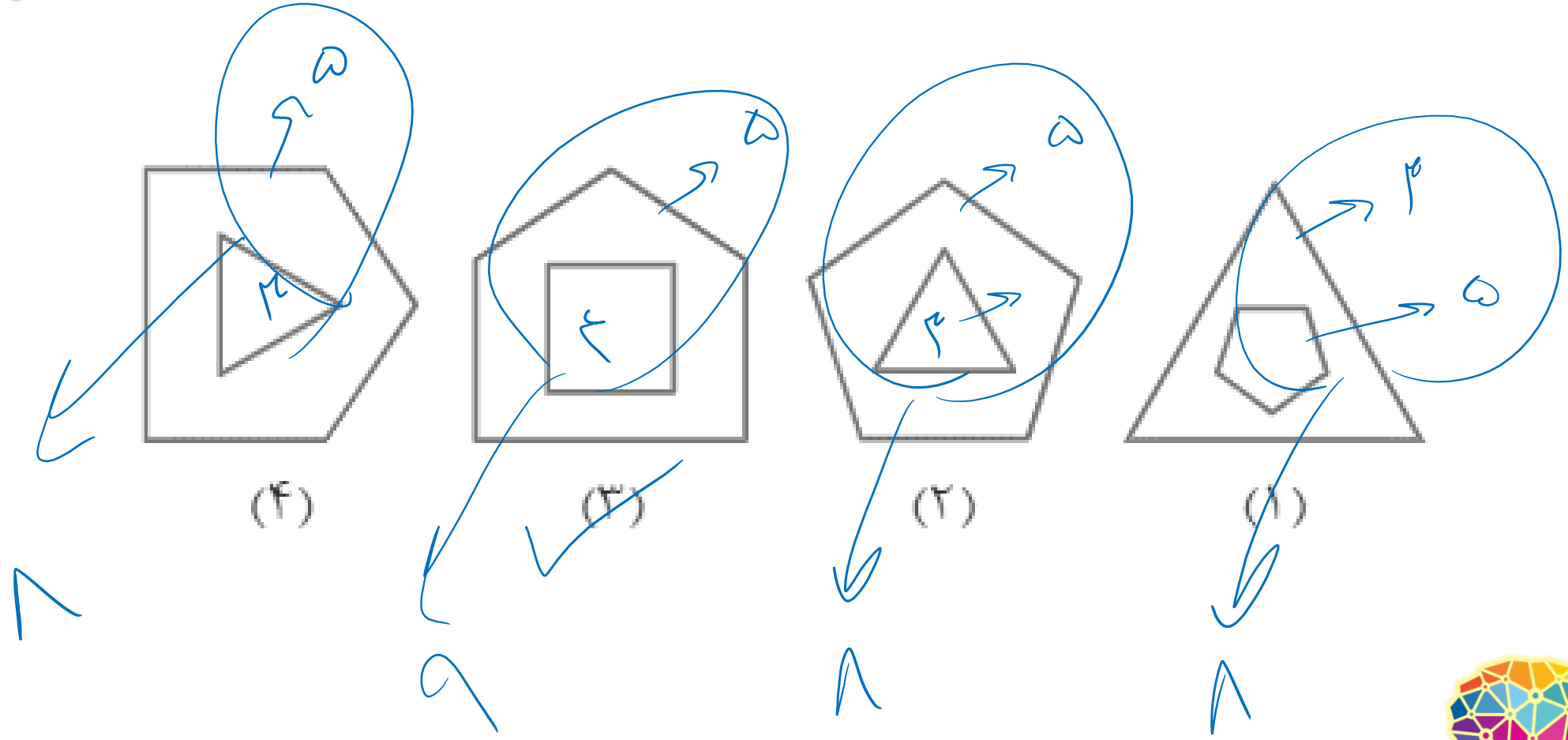



هوش تصویری

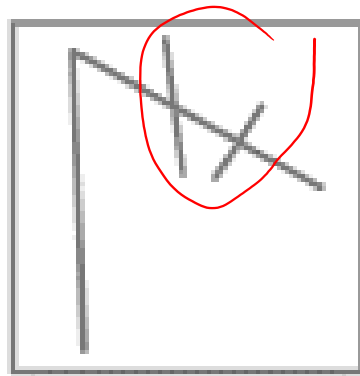

(۴)

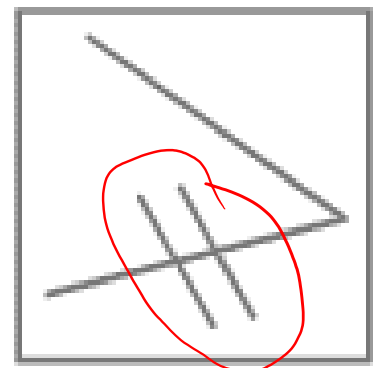

(۳)

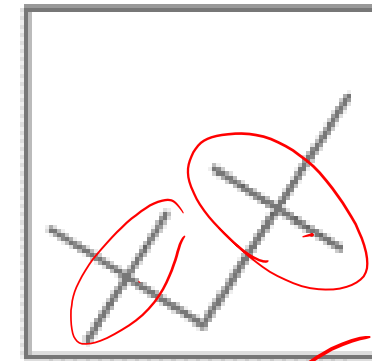

(۲)

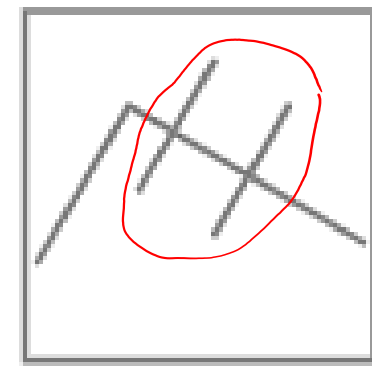

(۱)





هوش تصویری

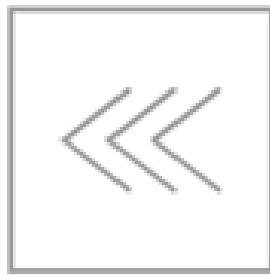

(۵)

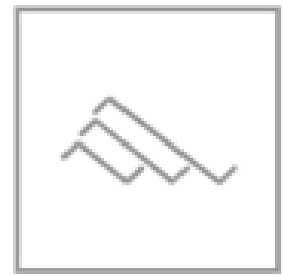

(۴)



(۳)

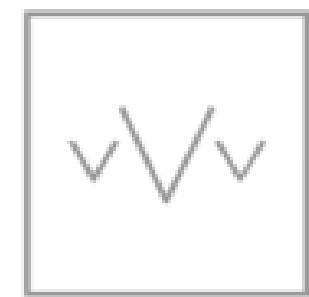

(۲)

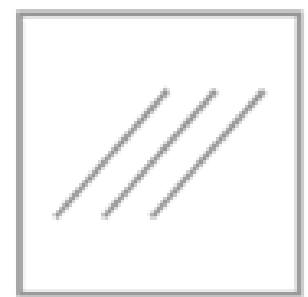

(۱)





هوش تصویری

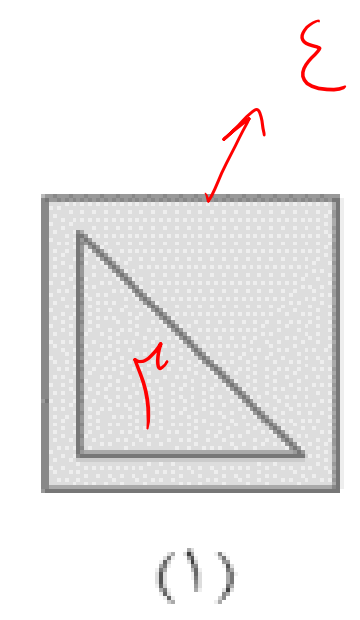
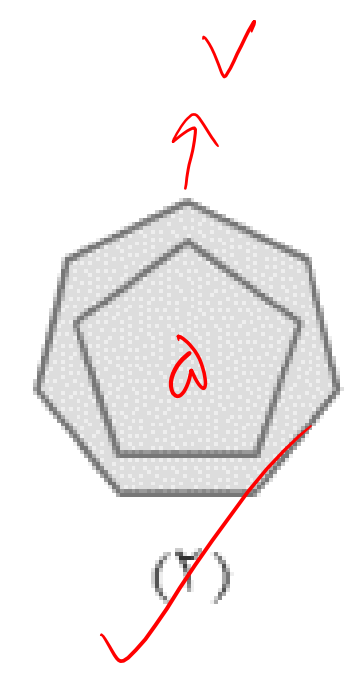
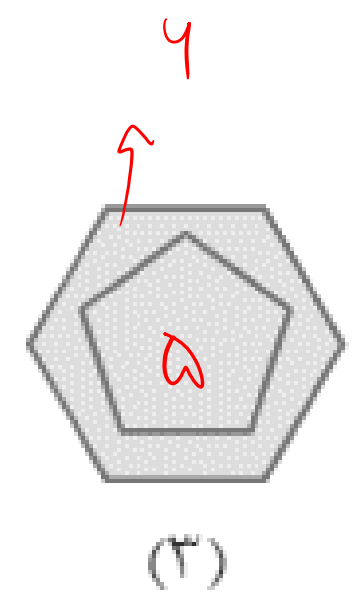
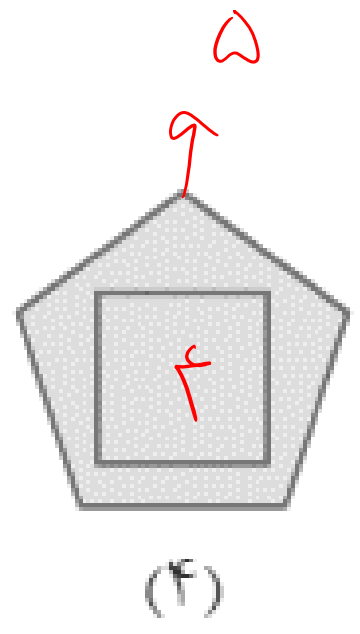



هوش تصویری

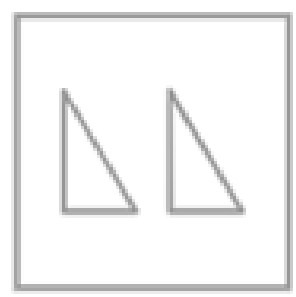

(۵)



(۴)

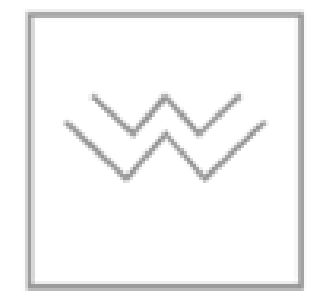

(۳)

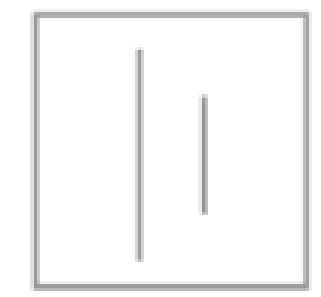

(۲)

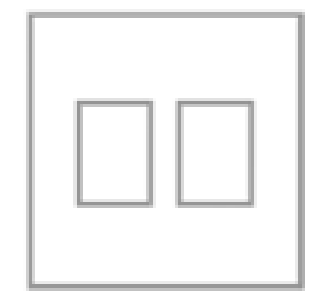

(۱)





هوش تصویری

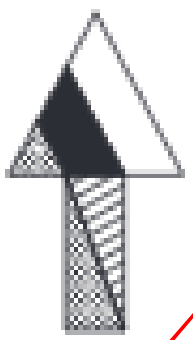

(۱)

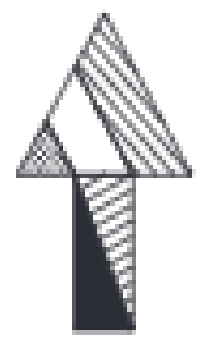

(۲)

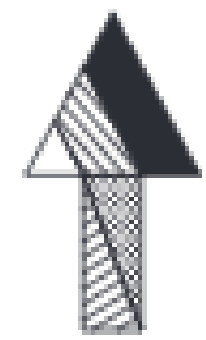

(۳)

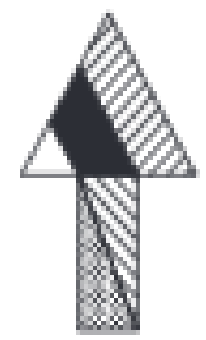

(۴)



هوش تصویری



(۱)

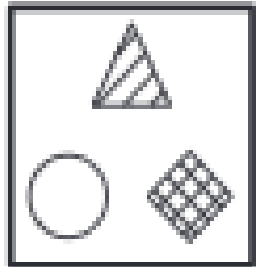

(۲)

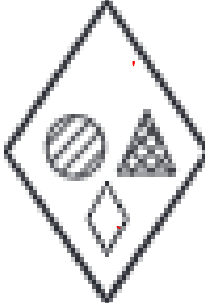

(۳)

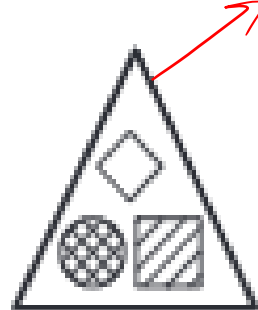

(۴)

مربع
دایره
موزیک
مربع



هوش تصویری

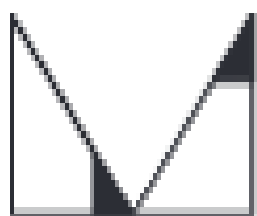

(۱)

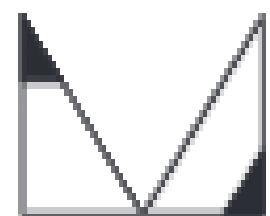

(۲)

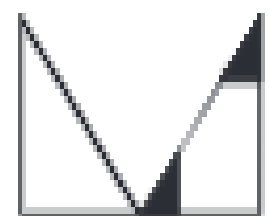

(۳)

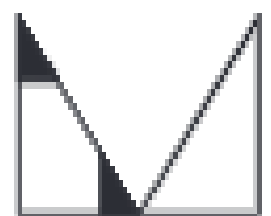

(۴)



هوش تصویری

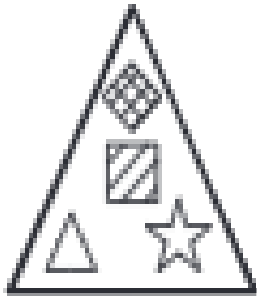

(۱)

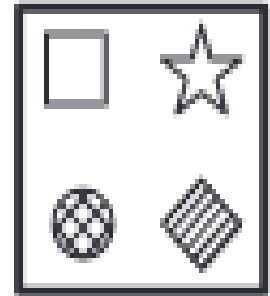

(۲)



(۳)



(۴)





هوش تصویری

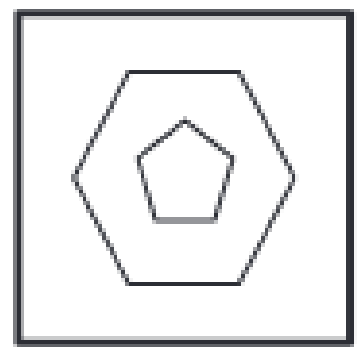

(۱)

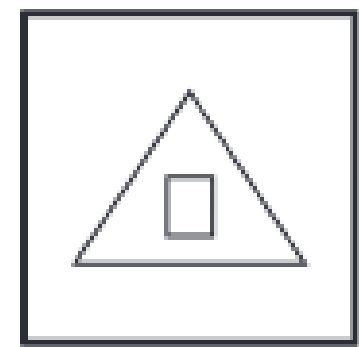

(۲)

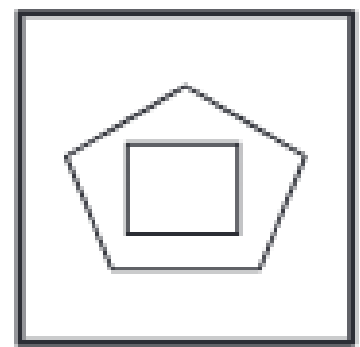

(۳)

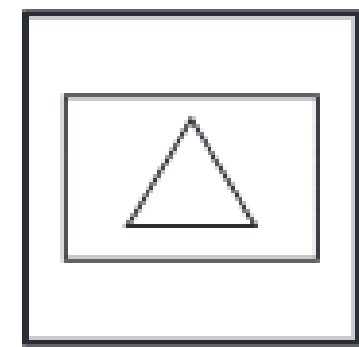

(۴)





هوش تصویری

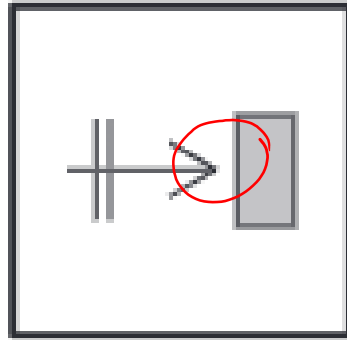

(۱)

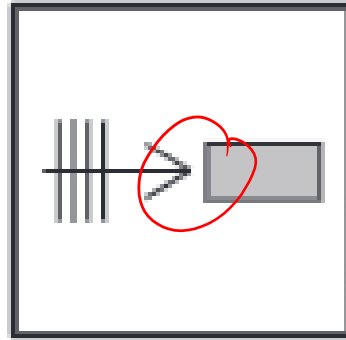

(۲)

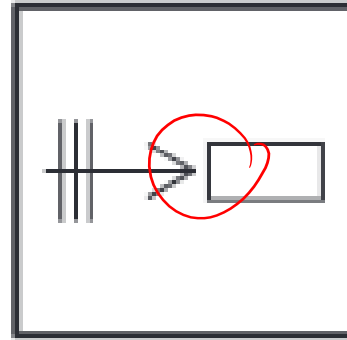

(۳)

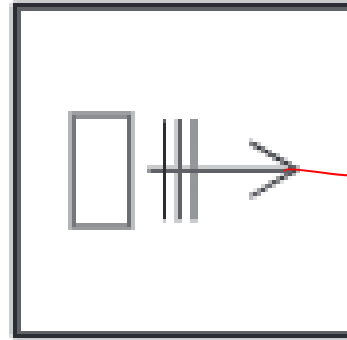

(۴)

پست من





هوش تصویری

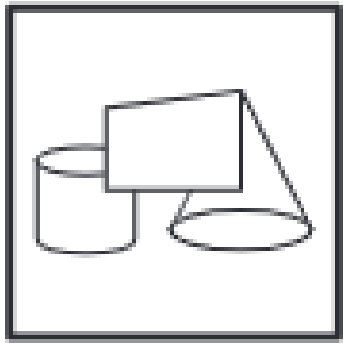

(۱)

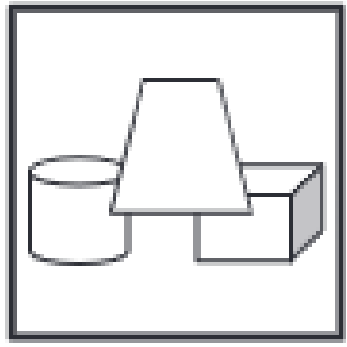

(۲)

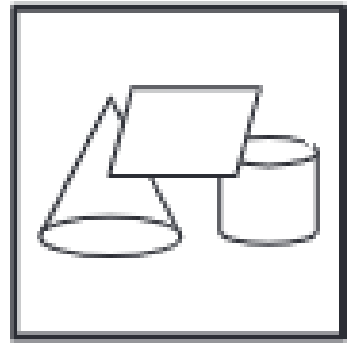

(۳)

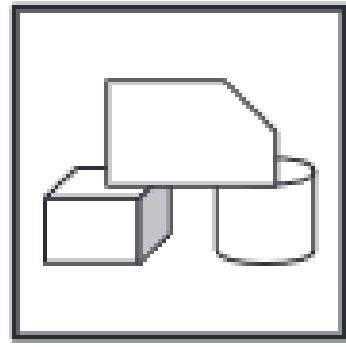

(۴)



هوش تصویری

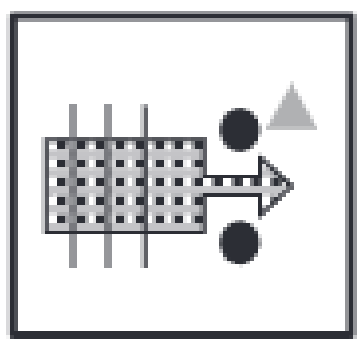

(۱)

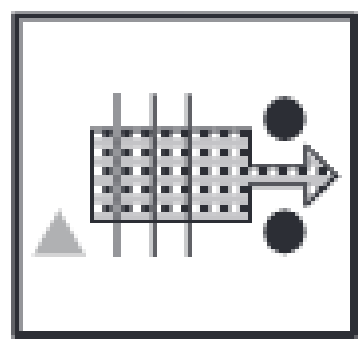

(۲)

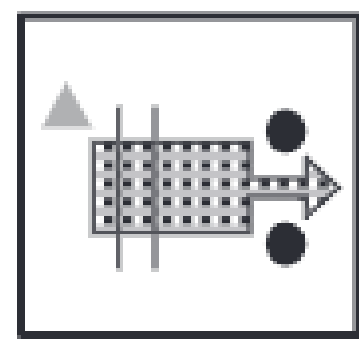

(۳)

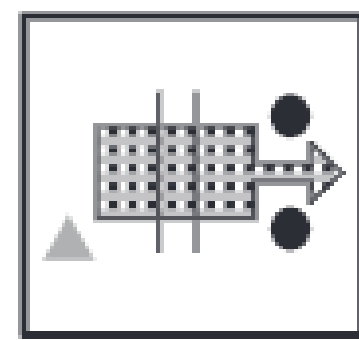

(۴)





هوش تصویری

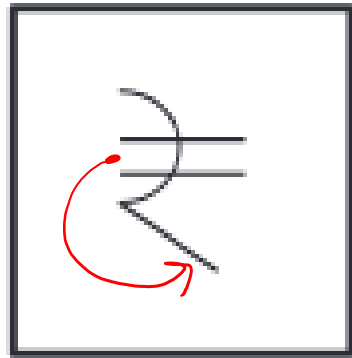

(۱)

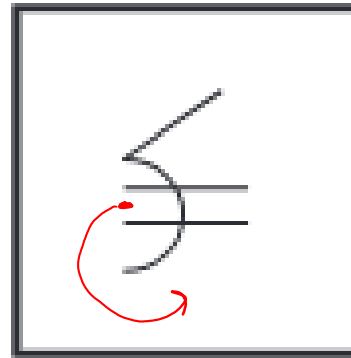

(۲)

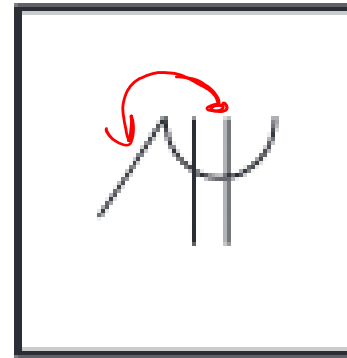

(۳)

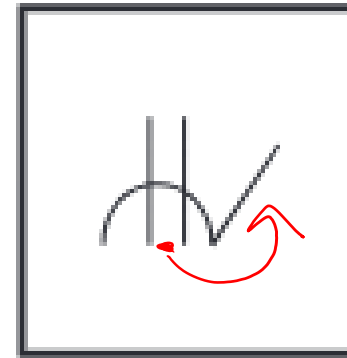

(۴)

دوران





هوش تصویری

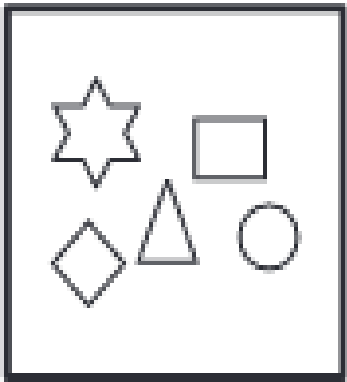

(۱)

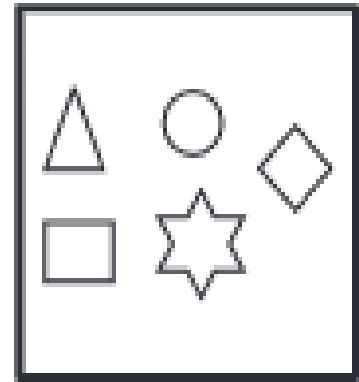

(۲)

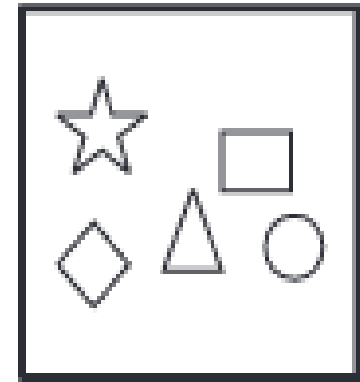

(۳)

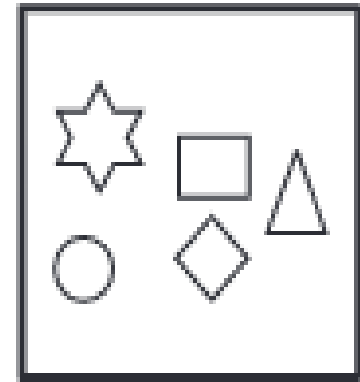

(۴)





هوش تصویری



(۱)

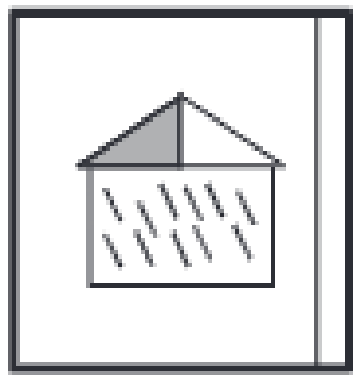

(۲)



(۳)

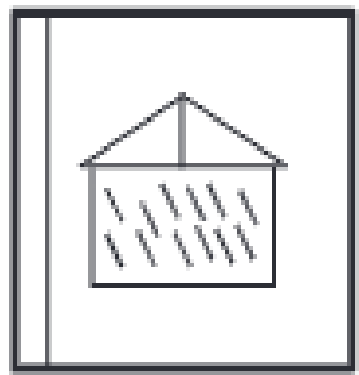

(۴)





هوش تصویری

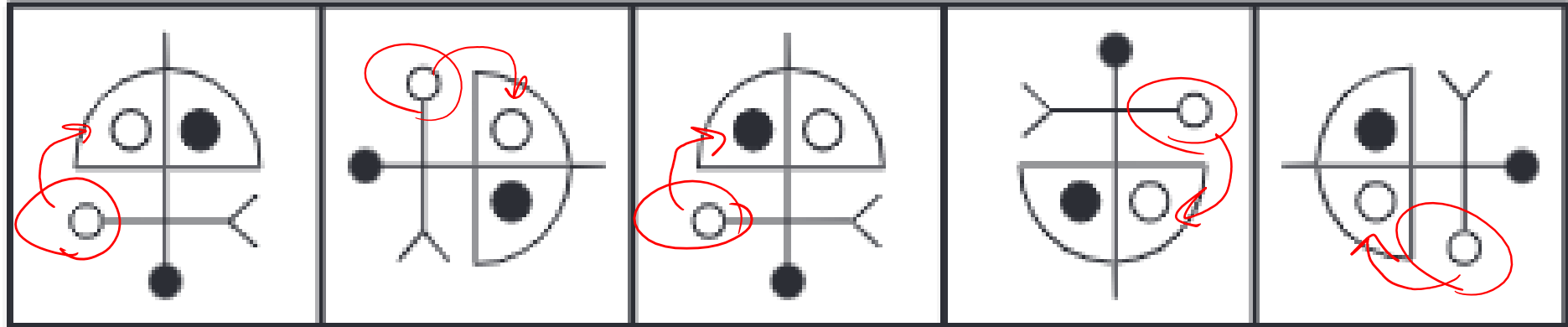

(۱)

(۲)

(۳)

(۴)

(۵)

جواب (۱)

