



# هوش کمپلکس

ششم

## هوش کمپلکس

هوش • استعداد تحلیلی • خلاقیت

تخصصی ترین مرجع پرسش های چندگزینه ای

مؤلف: مهندس مصطفی باقری

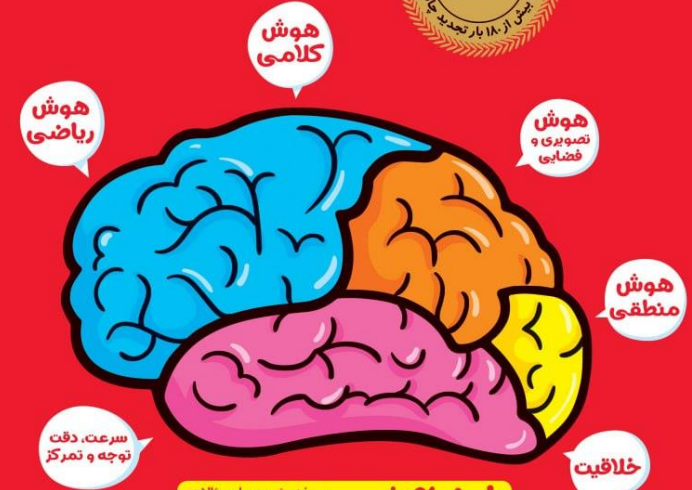

فول آپشن +  
غنی شده با سوالات  
آزمون ورودی ۱۴۰۳

آموزش • تست • آزمون

4K ULTRAHD  
ویرایش جانانه

آموزش، درسنامه، نکات کلیدی، مثال های حل شده، سوالات طبقه بندی شده، به همراه افزونه های آنلاین شامل آزمون های دوره ای هر بخش و آزمون های ورودی تیزهوشان با پاسخنامه ی خیلی تشریحی





# هوش کمپلکس

در سوال های زیر ، تصویر X روی کاغذ شفاف کشیده شده است. پس از تا کردن آن از محل خط چین کدام تصویر دیده میشود؟

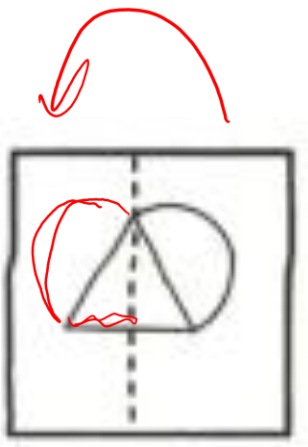

(X)



(1)

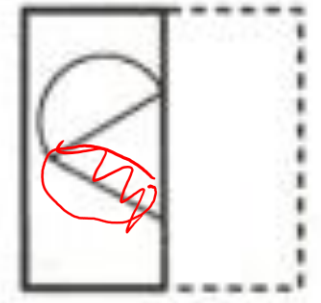

(2)

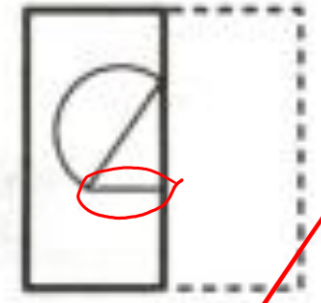

(3)

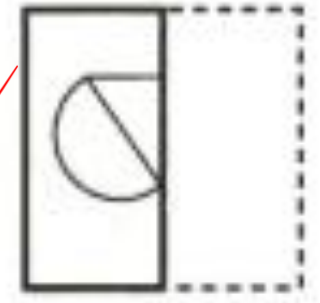

(4)





# صورت کھینکیں



(X)

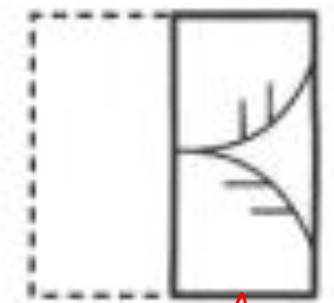

(1)

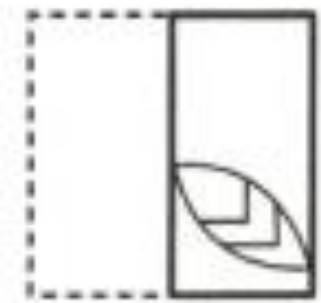

(2)

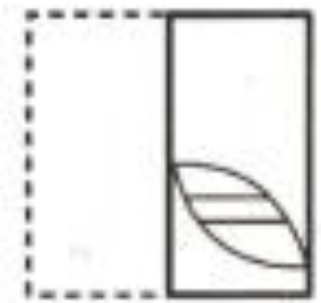

(3)



(4)





# صورت کھینکیں

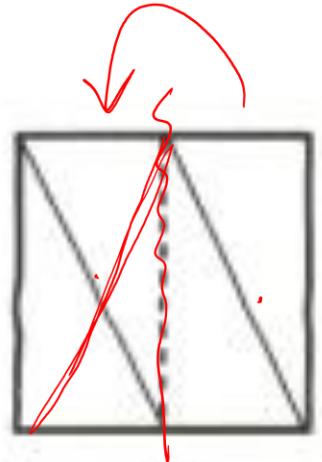

(X)



(۱)



(۲)



(۳)

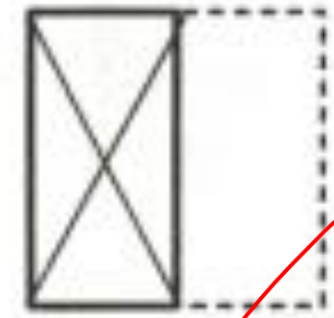

(۴)





1+1=2  
1x2=  
x=+

# صورت کھینکیں

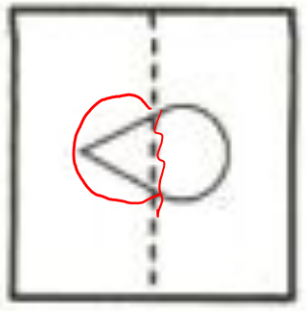

(X)

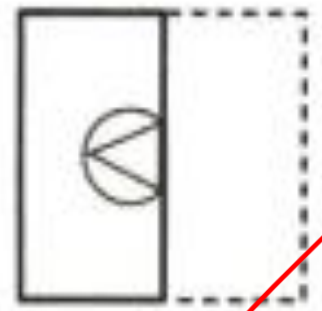

(1)

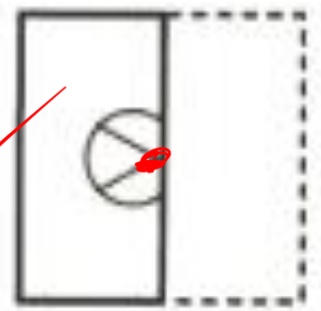
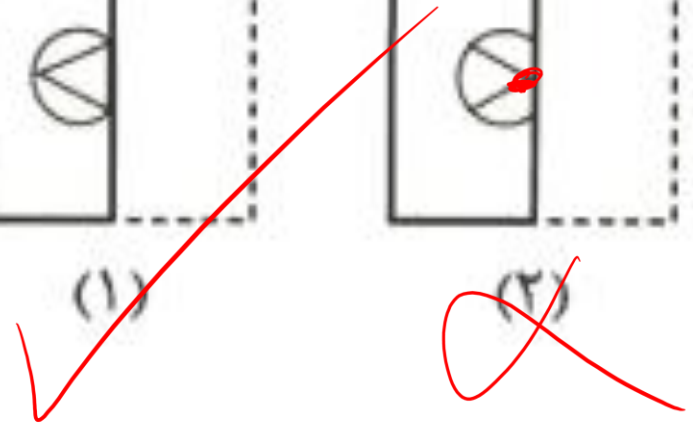

(2)

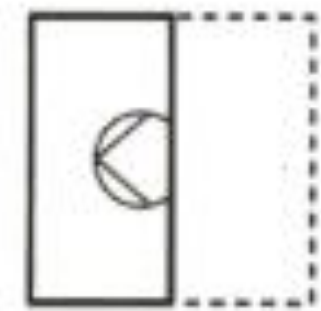

(3)

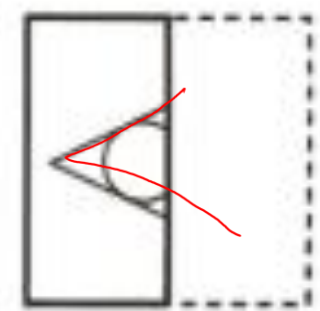

(4)





1+1=2  
1+2=3  
x=+

# صورت کھیل

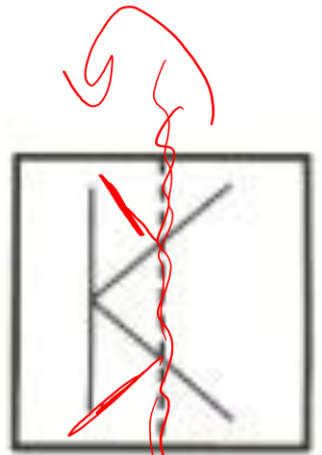

(X)

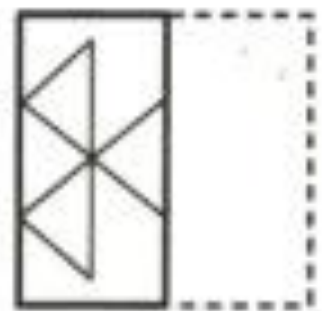

(1)

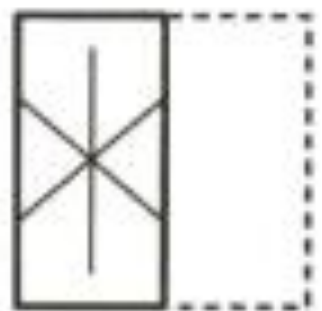

(2)

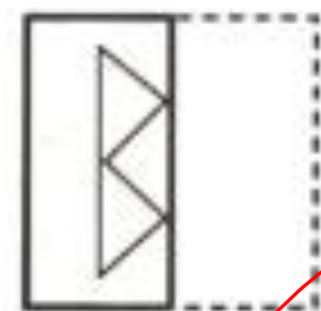

(3)

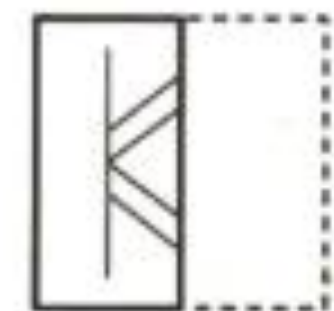

(4)





1+1=2  
1+2=3  
x=+

# صورت کھینکیں

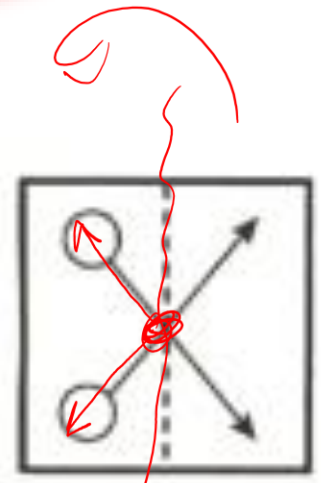

(X)

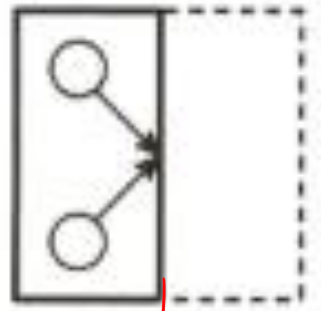

(A)

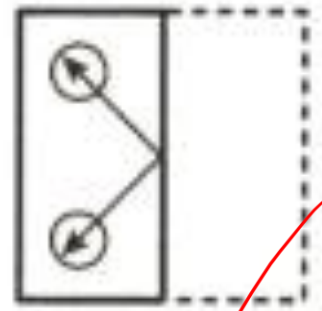

(B)



(C)

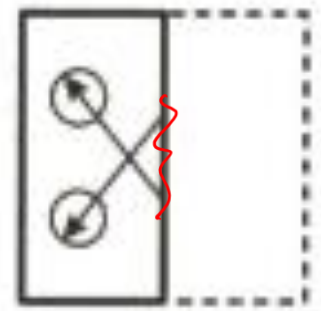

(D)





$1+1=2$   
 $1 \times 2 =$   
 $x = +$

# صورت کھیلیں

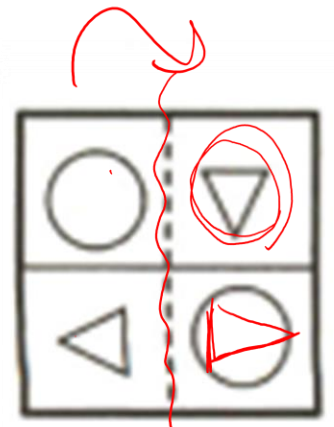

(X)

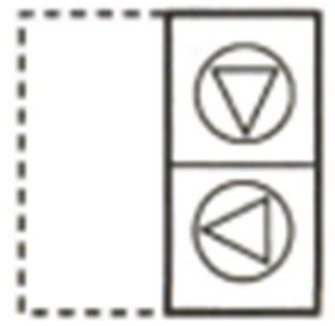

(1)

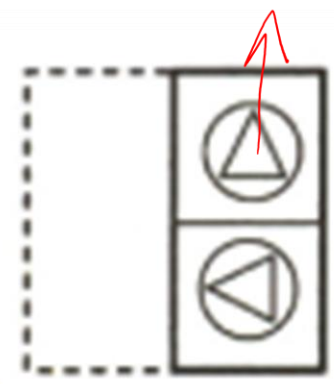

(2)

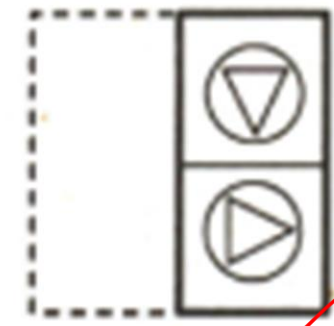

(3)

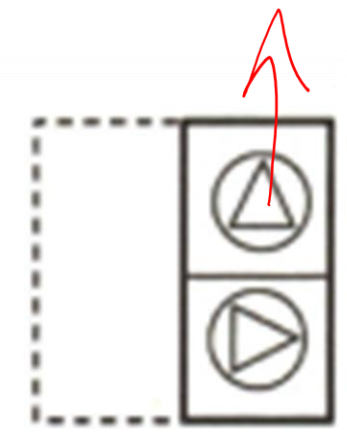

(4)







# حوش کھیلکس

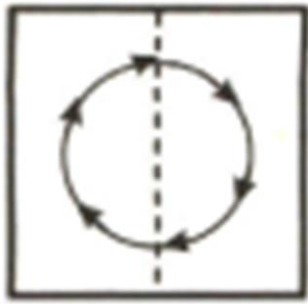

(X)

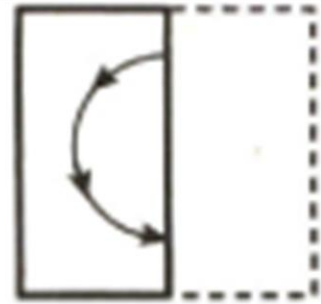

(1)

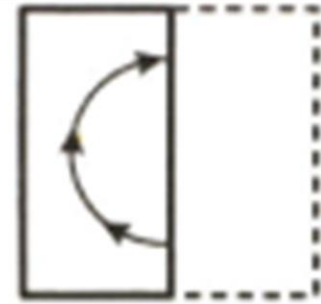

(2)

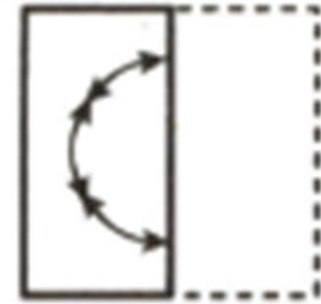

(3)

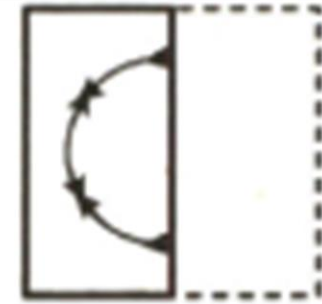

(4)





# صورت کھینکیں



(X)



(۱)



(۲)

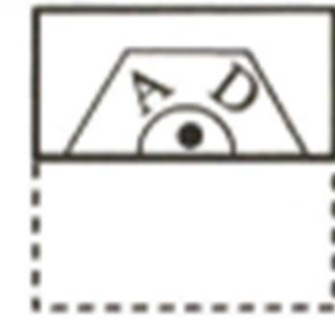

(۳)



(۴)

کدو ۱۵





# صورت کھینکیں



(X)

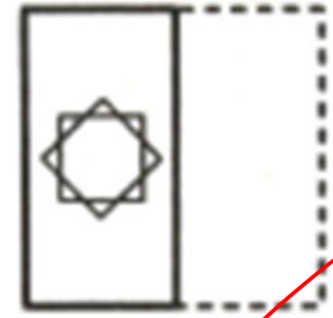

(1)

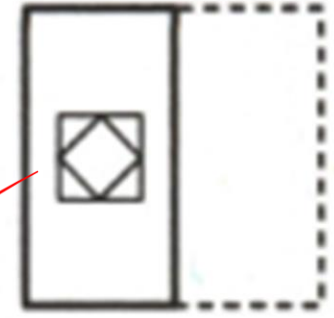

(2)



(3)

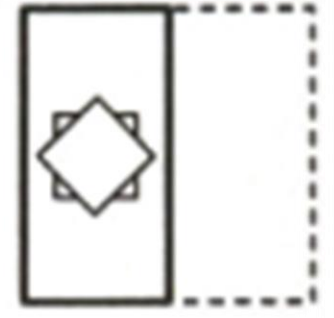

(4)





1+1=2  
1+2=3  
x=+

# حوش كميكي

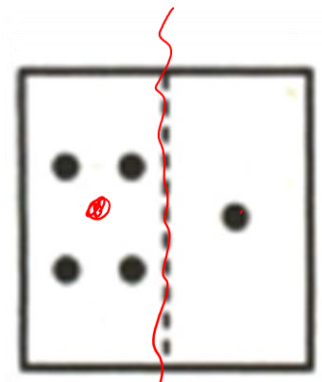

(X)



(1)

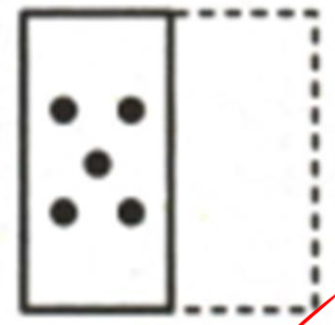

(2)

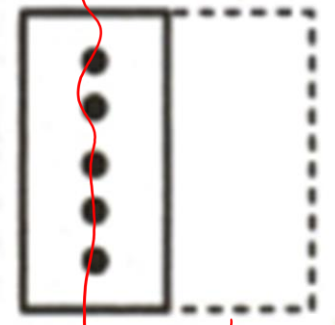

(3)



(4)





1+1=2  
1+2=3  
x=+

# صورت کھینکیں

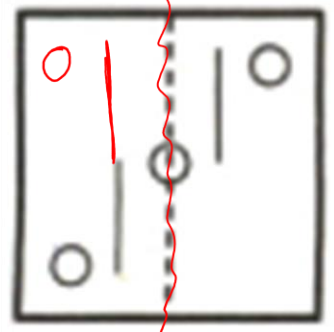

(X)



(۱)

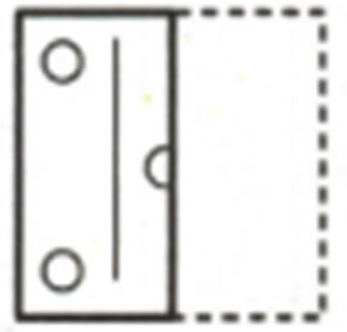

(۲) ✓

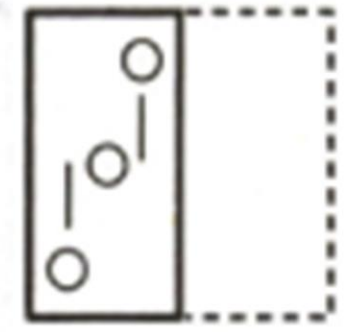

(۳)

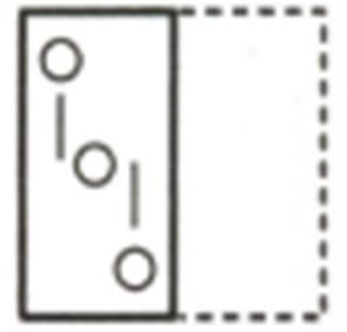

(۴)





# صورت کھینکیں

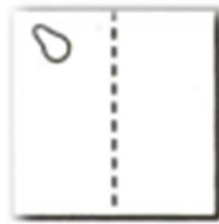

(X)

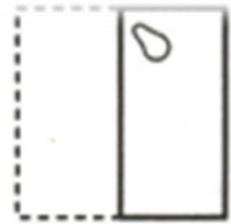

(1)



(2)

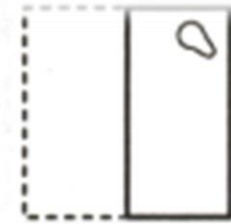

(3)



(4)





1+1=2  
1+2=3  
x=+

# صورت کھیلیں

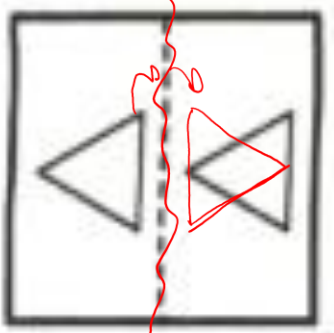

(X)

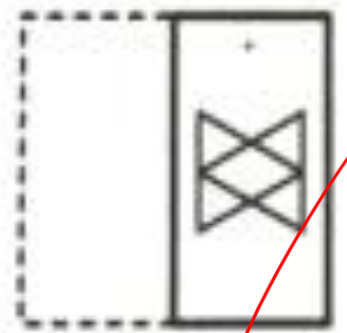

(1)

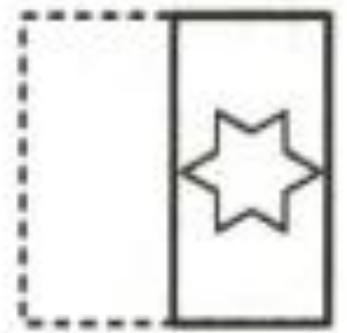

(2)



(3)



(4)





# صورت کمپلیٹ کریں

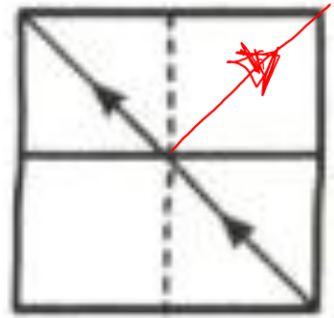

(X)

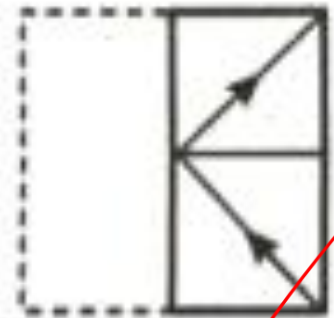

(1)

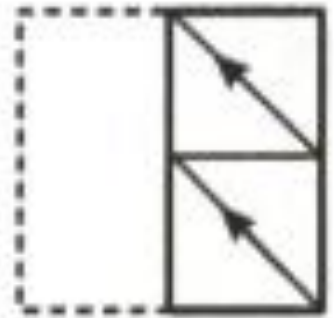

(2)

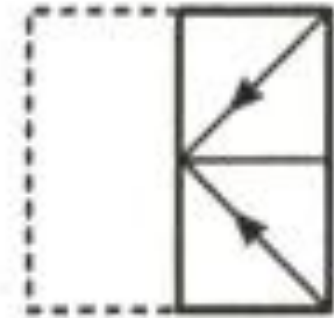

(3)

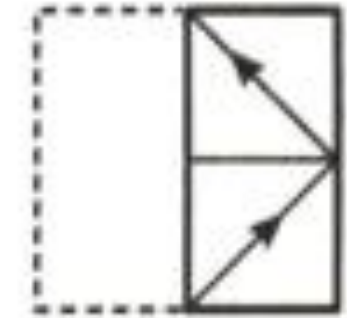

(4)







$1+1=2$   
 $1 \times 2 =$   
 $x = +$

# صورت کھینکیں

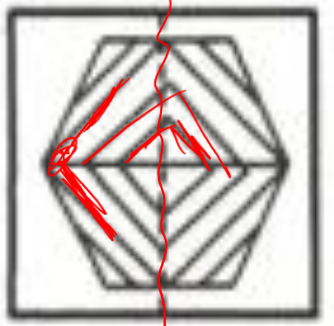

(X)



(1)

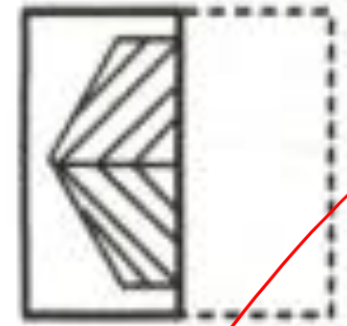

(2) ✓

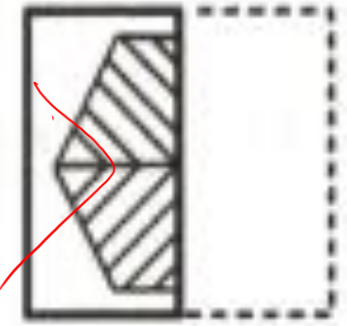

(3)

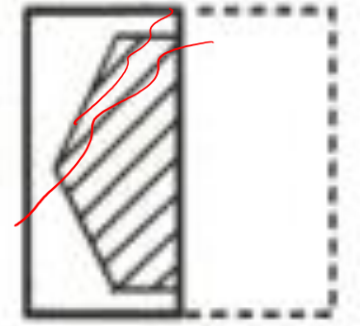

(4)





# صورت کھینکیں

9



(X)



(1)



(2)



(3)

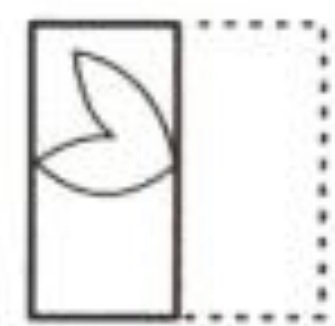

(4)

155





$1+1=2$   
 $1 \times 2 =$   
 $x = +$

# صورت کھینچیں

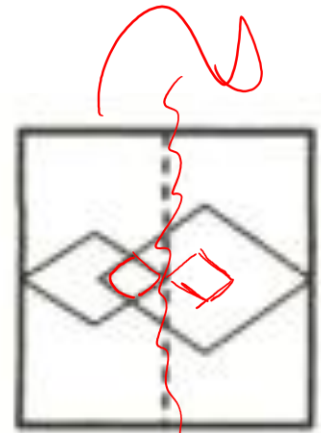

(X)

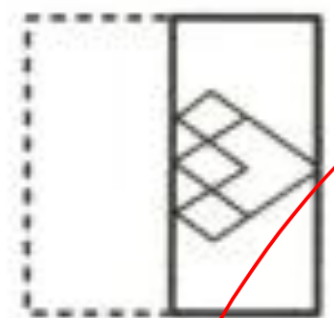

(✓)

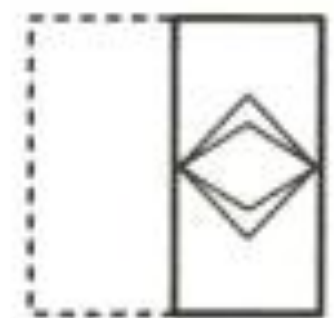

(X)

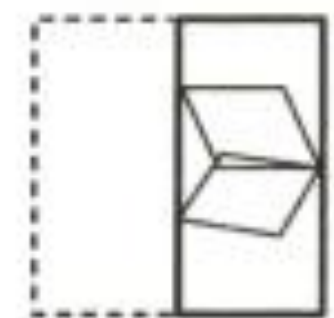

(X)

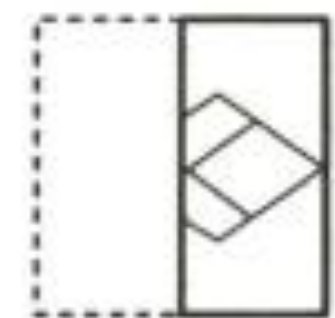

(X)





# صورت کھینکیں

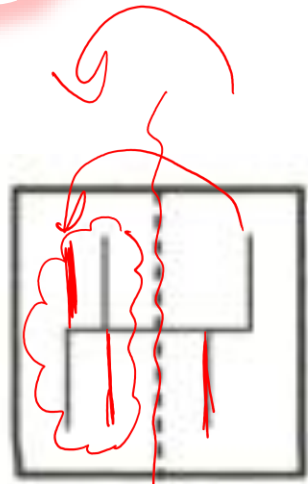

(X)

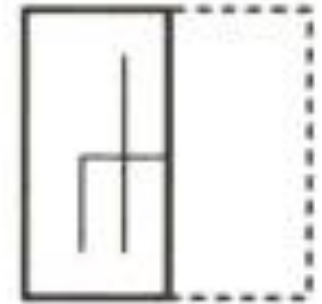

(۱)



(۲)

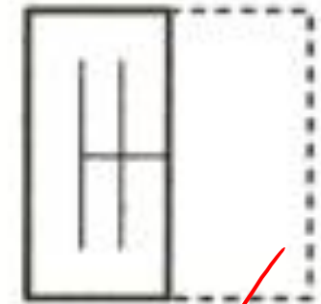

(۳)

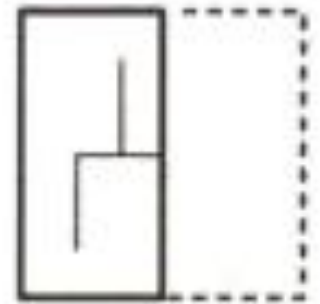

(۴)





# هوش کمپلر

کاغذ تا شده ، پس از سوراخ و باز شدن به کدام گزینه تبدیل خواهد شد ؟

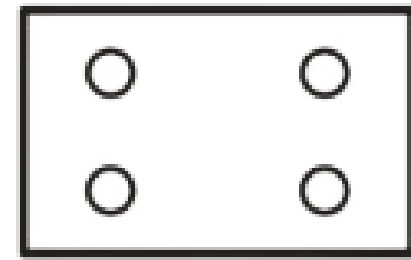
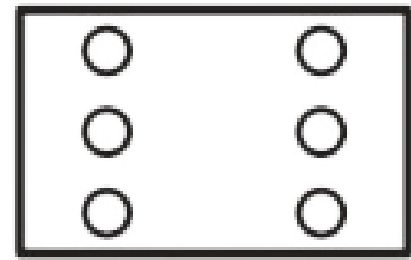
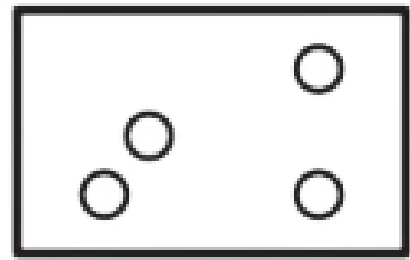
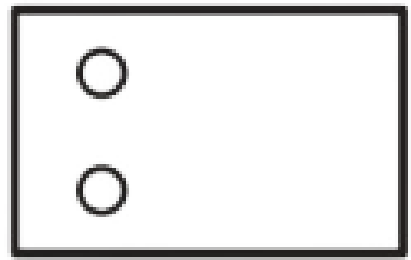
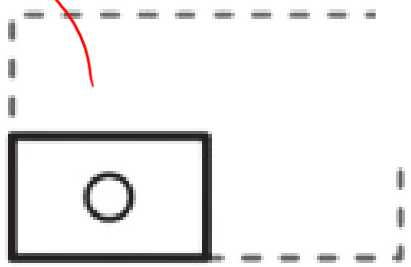
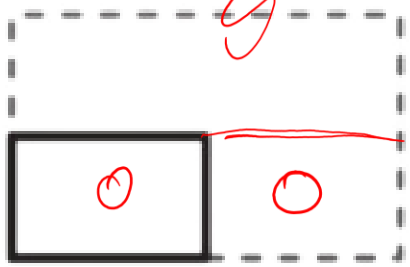
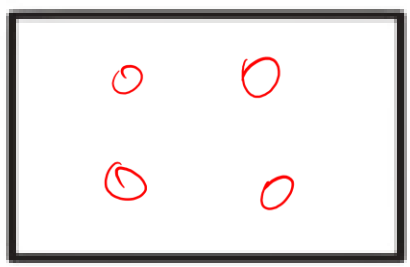

۴

۳

۲

۱





$1+1=2$   
 $1+2=$   
 $x=+$

# صورت کھیلیں

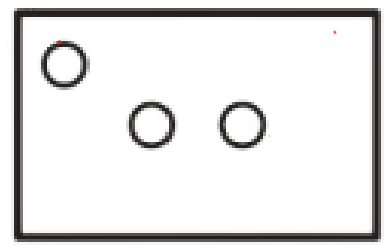
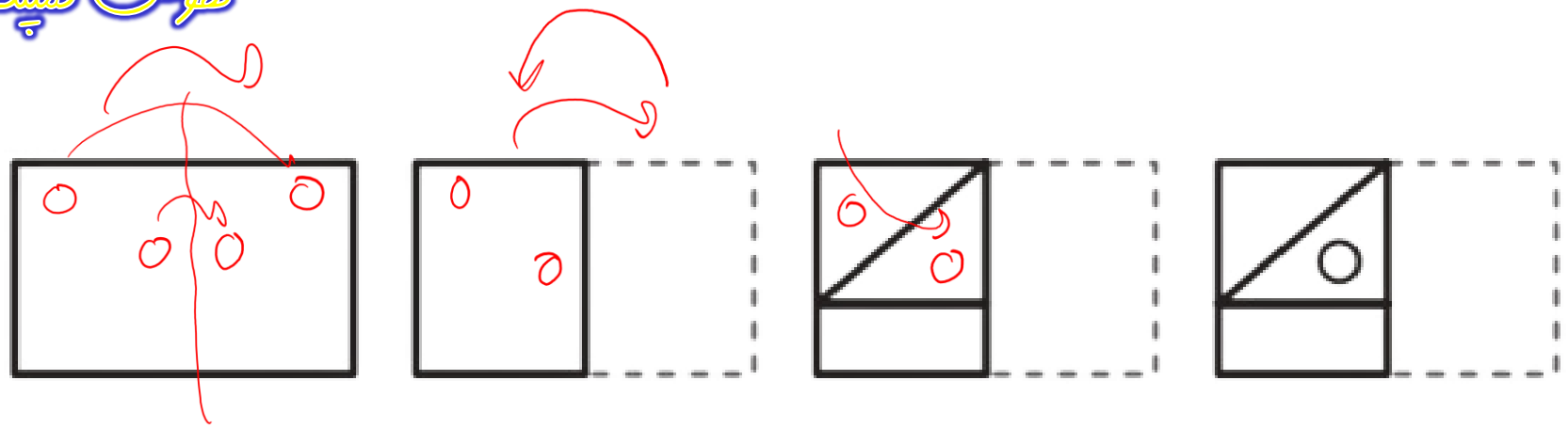

۴

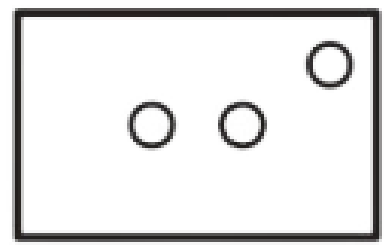

۳

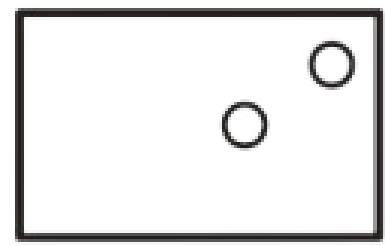

۲

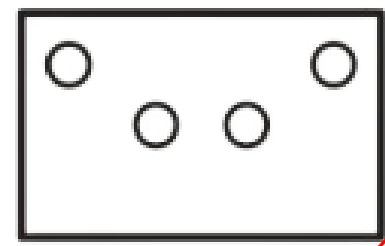

۱ ✓





$1+1=2$   
 $1+2=$   
 $x=+$

# صورت کھینچیں

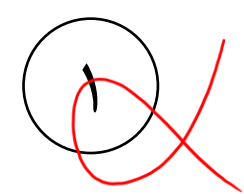
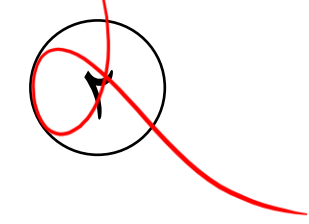
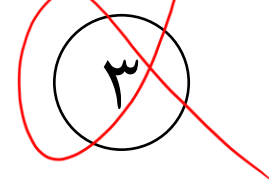
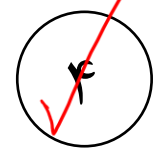
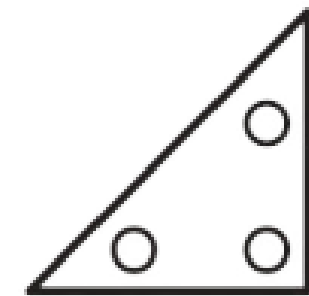
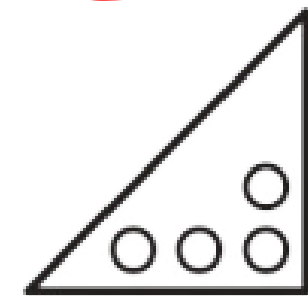
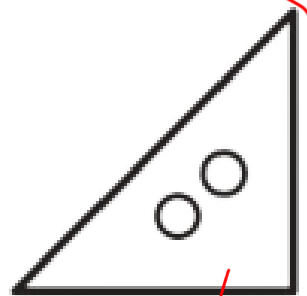
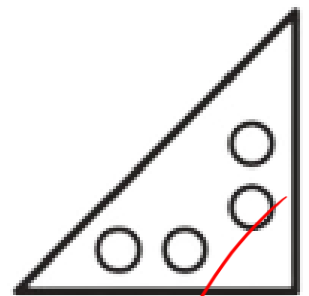
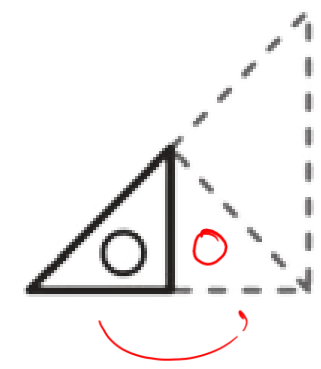
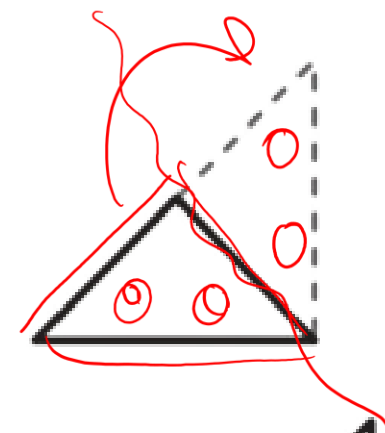
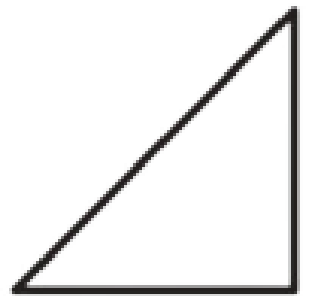



# صورت کھینچیں

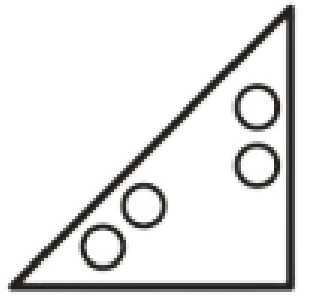
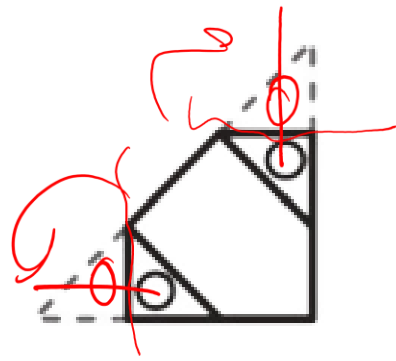
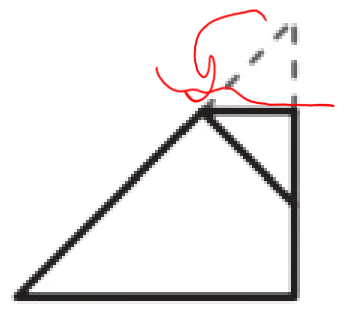
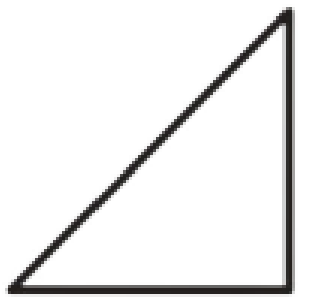

۴

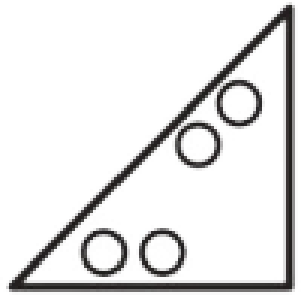

۳

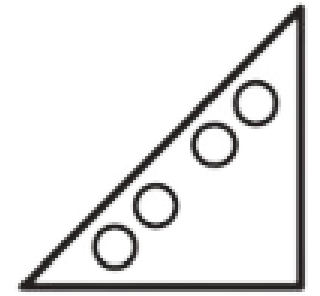

۲

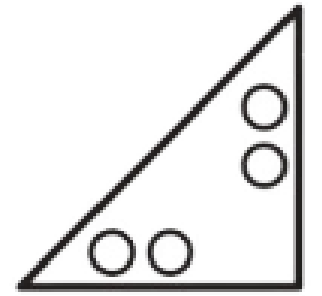

۱

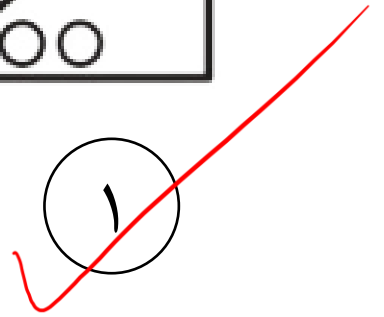





# هوئڻ ڪمپليٽ ڪريو

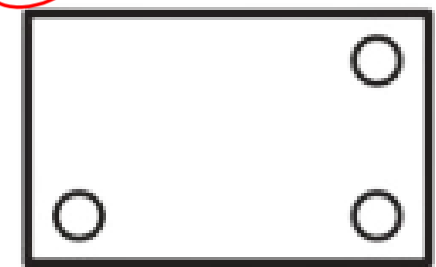
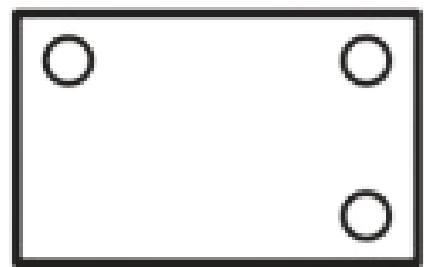
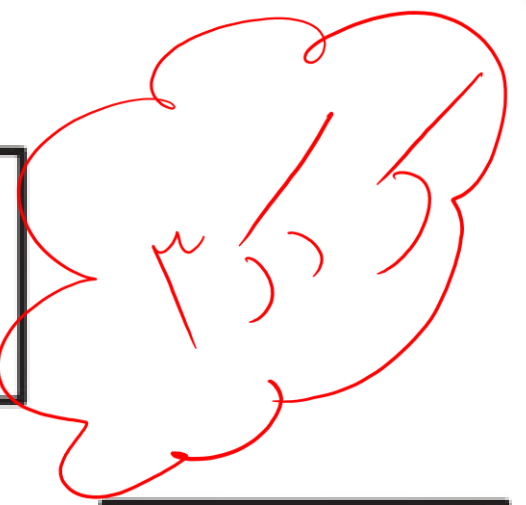
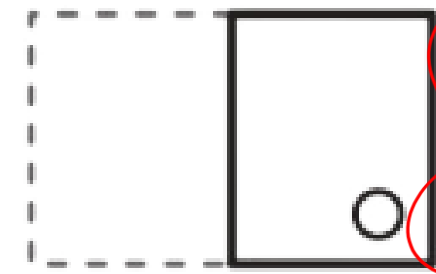
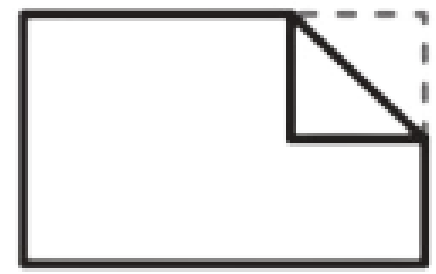
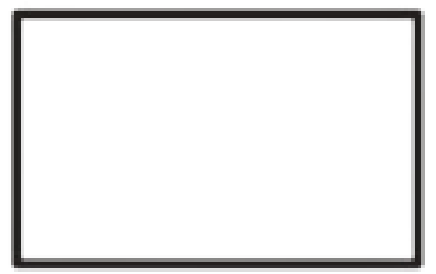

۴

۳

۲

۱





$1+1=2$   
 $1+2=3$   
 $x=+$

# صورت اکمل کریں

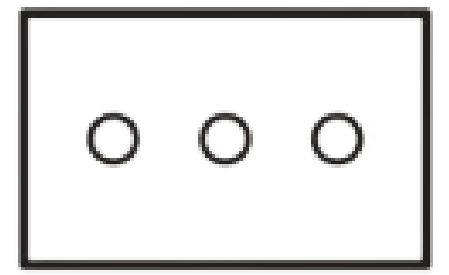
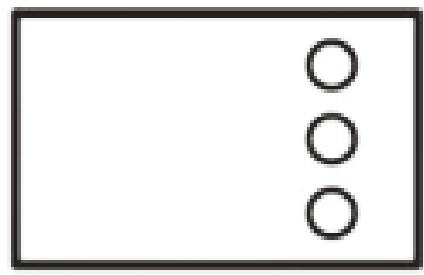
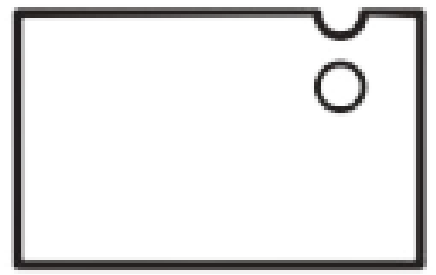
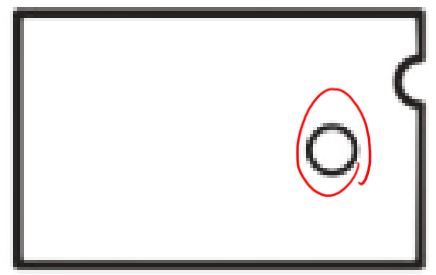
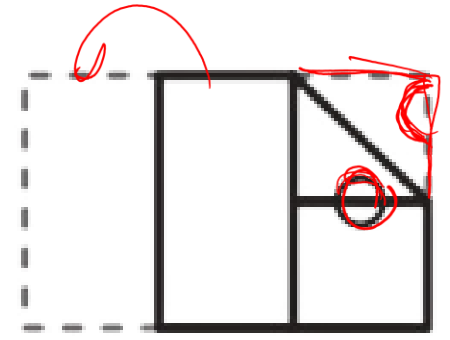
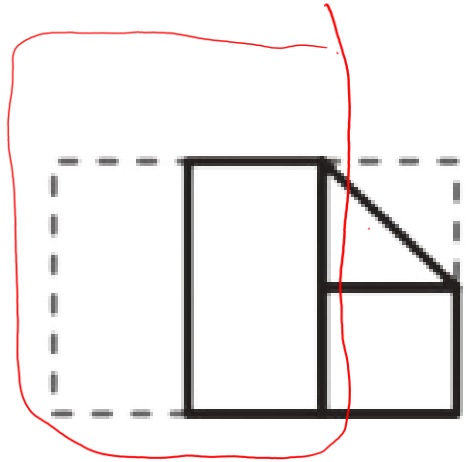
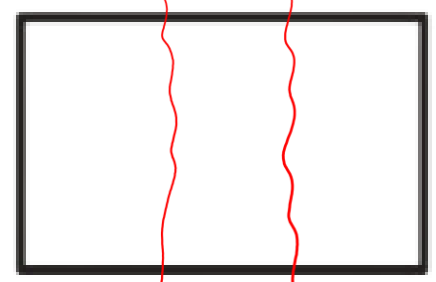

۴

۳

۲

۱

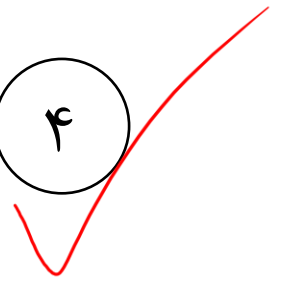



$1+1=2$   
 $1 \times 2 =$   
 $x = +$

# صورت کھینکیں

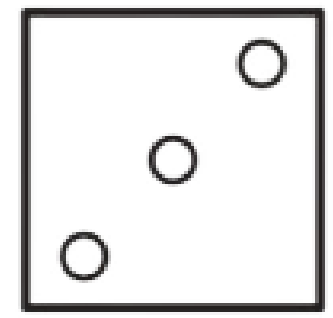
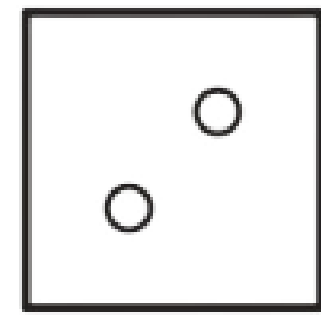
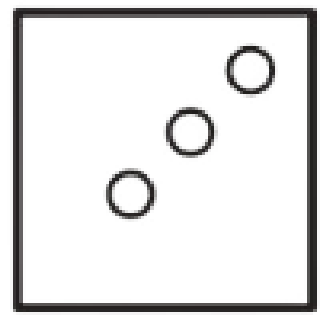
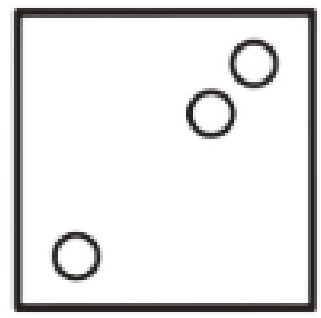
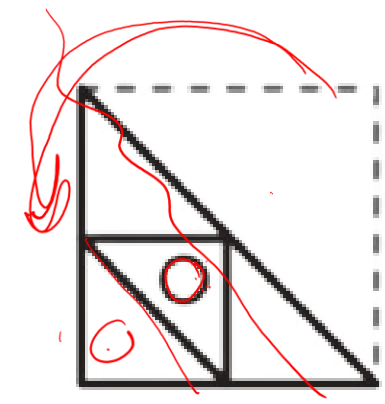
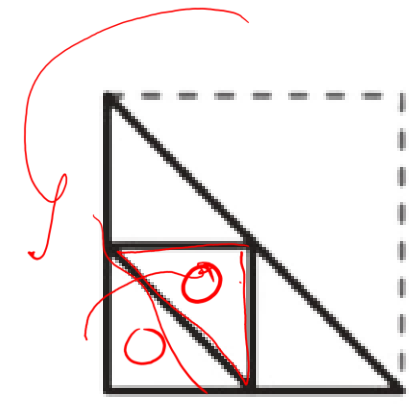
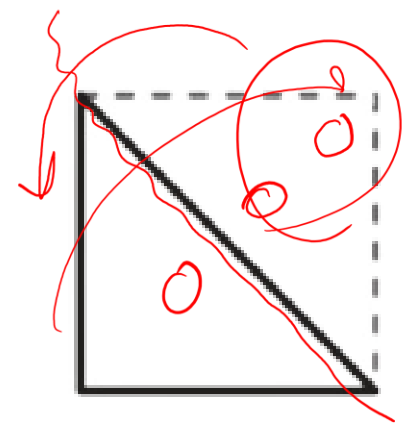
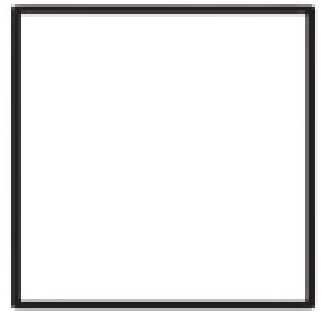

۴

۳ ✓

۲

۱





# صورت کھینکریں

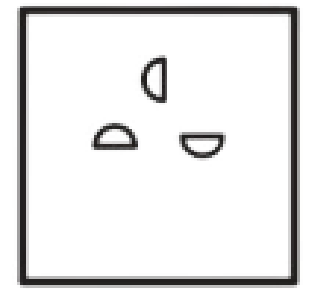
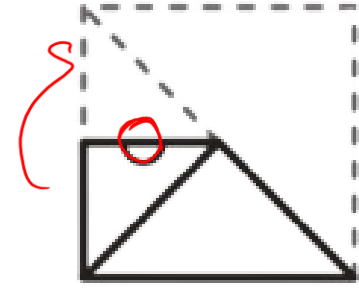
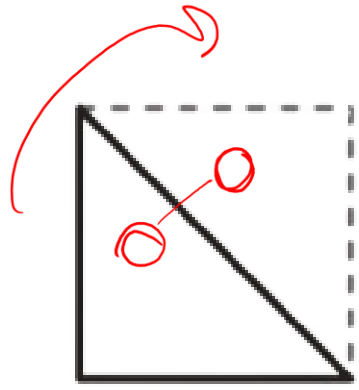
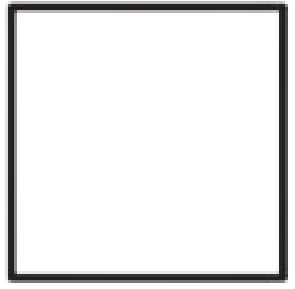

۴

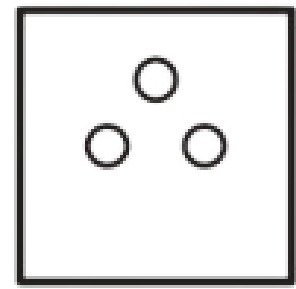

۳

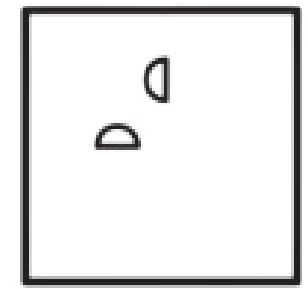

۲

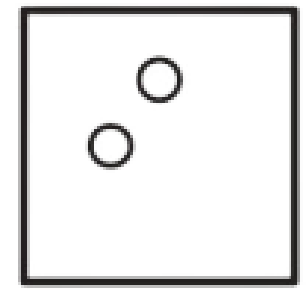

۱ ✓





# صورت کھینکیں

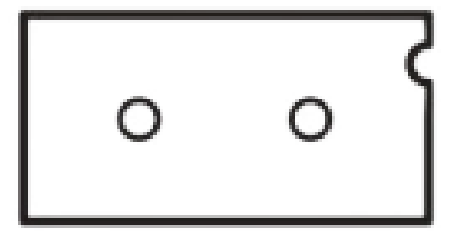
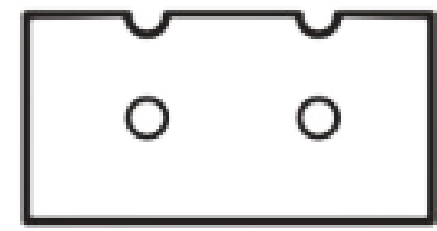
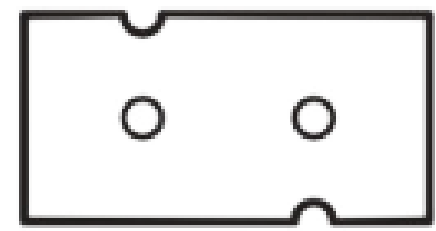
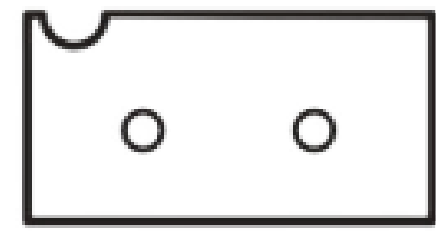
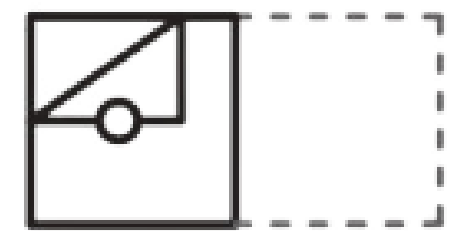
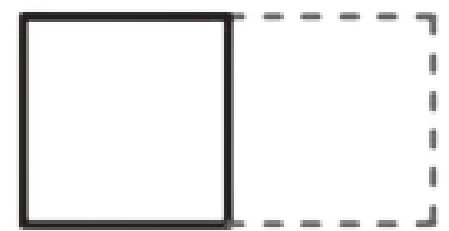

۴

۳

۲

۱





# صورت کھینکریں

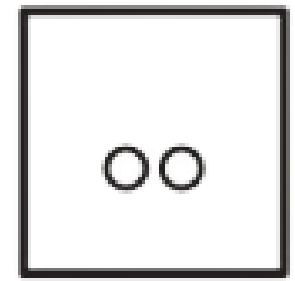
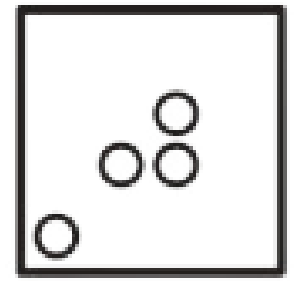
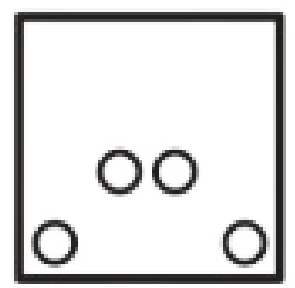
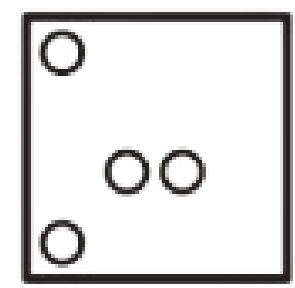
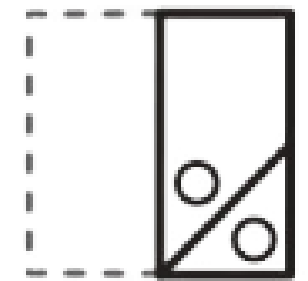
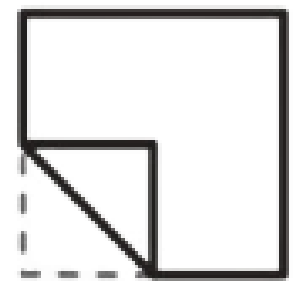
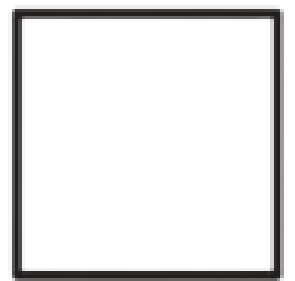

۴

۳

۲

۱





# هوئڻ ڪمپليٽ ڪريو

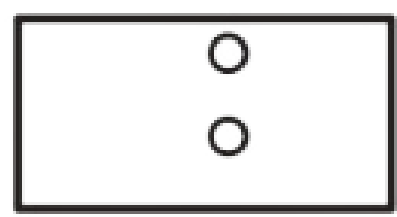
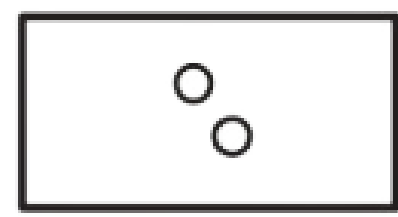
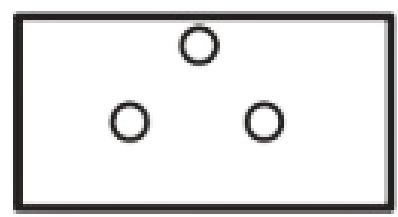
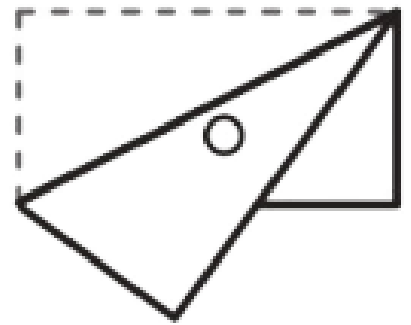

۴

۳

۲

۱





# هوئڻ ڪمپليٽ ڪريو

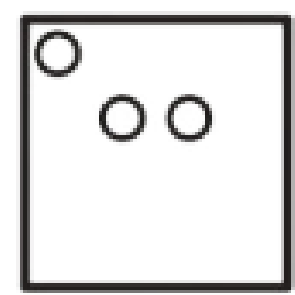
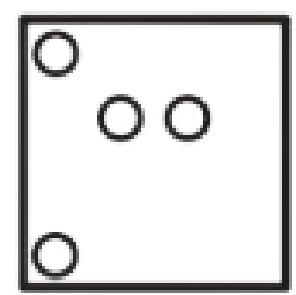
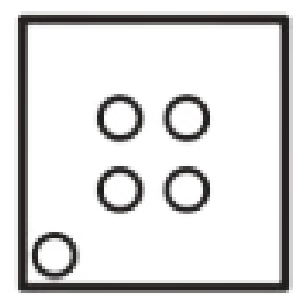
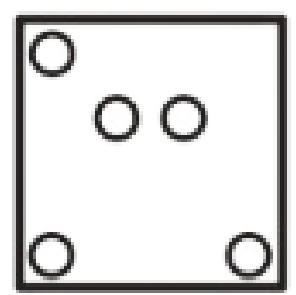
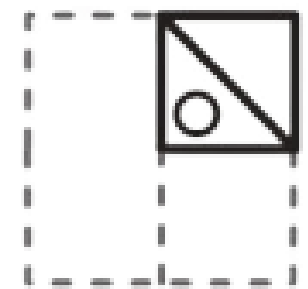
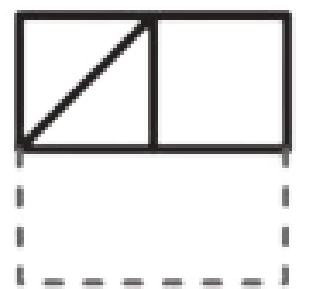
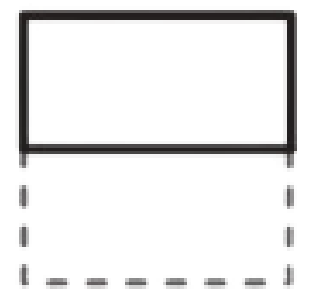
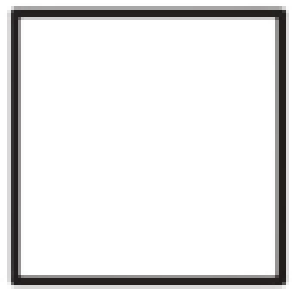

۴

۳

۲

۱







# صورت کھیل

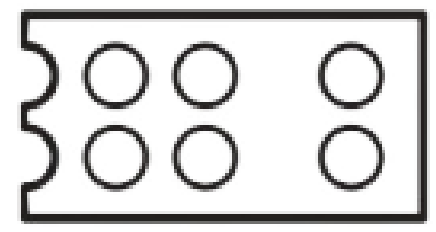
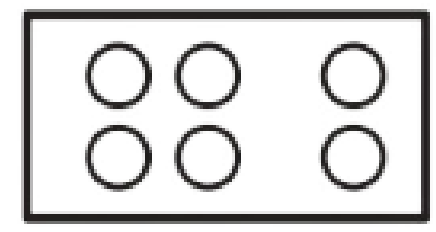
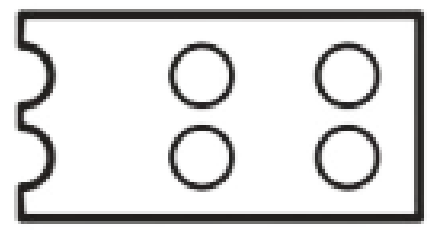
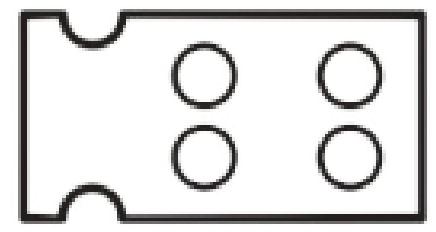
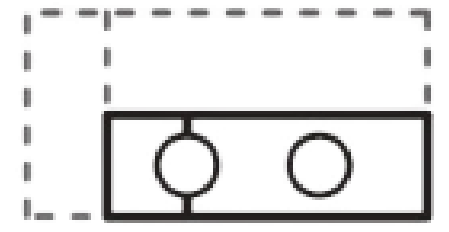
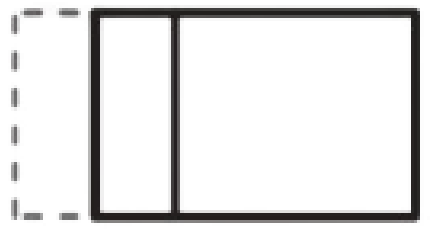
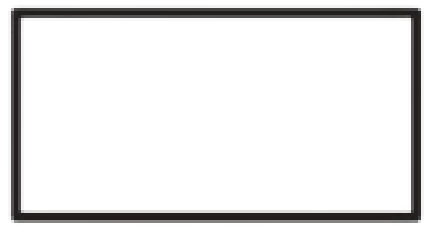

۴

۳

۲

۱





# هوئڻ ڪمپليٽ ڪريو

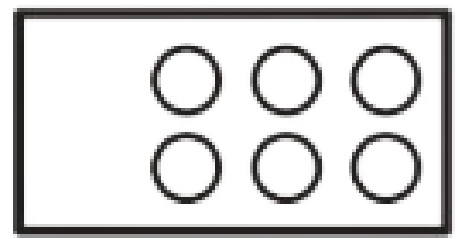
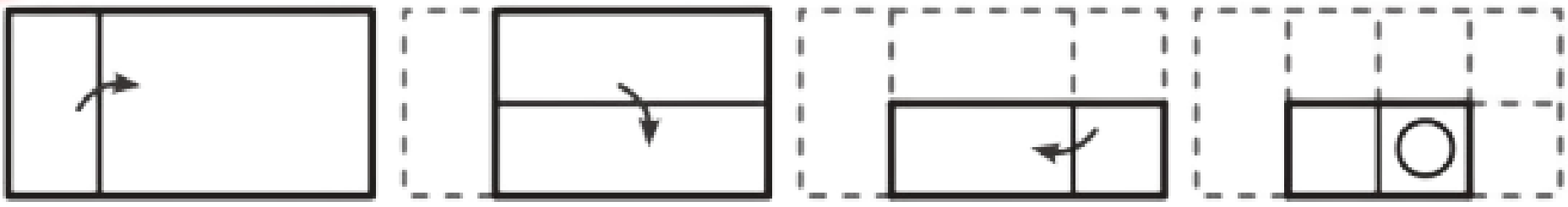

۴

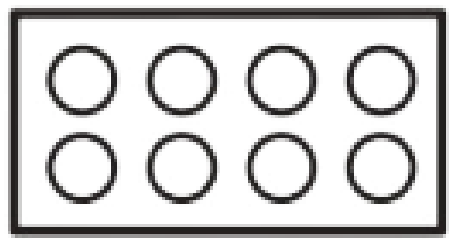

۳

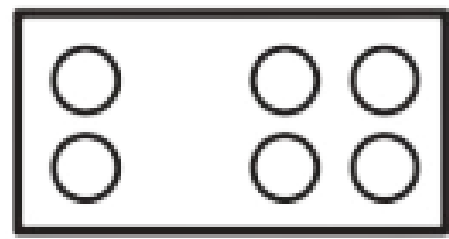

۲

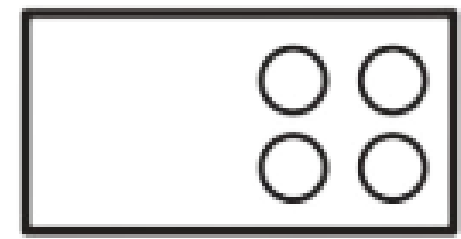

۱





# صورت کھینکے

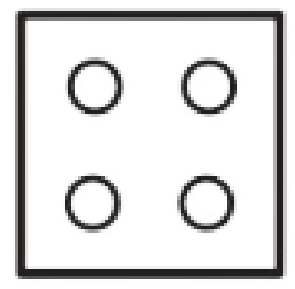
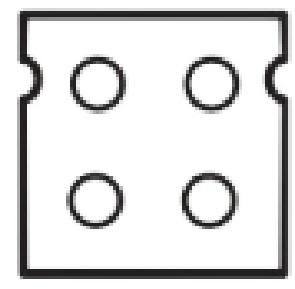
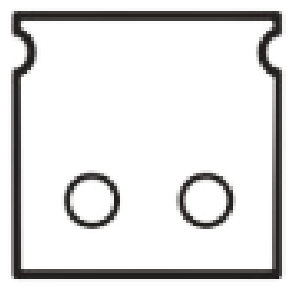
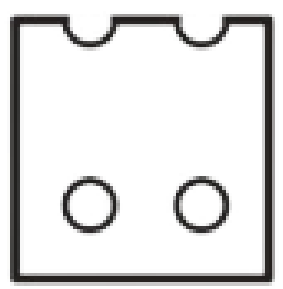
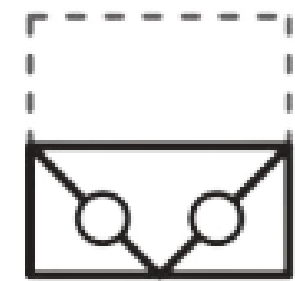
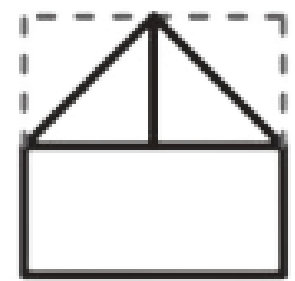
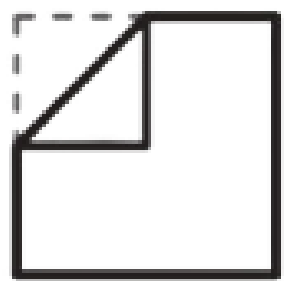
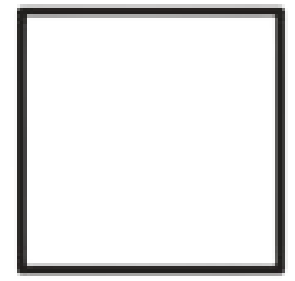

۴

۳

۲

۱





# صورت کھینک

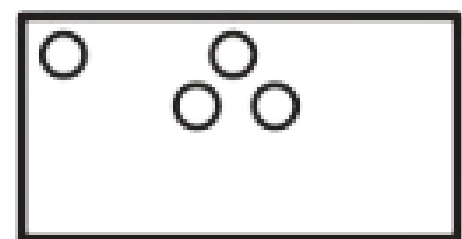
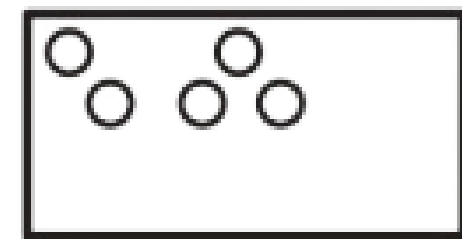
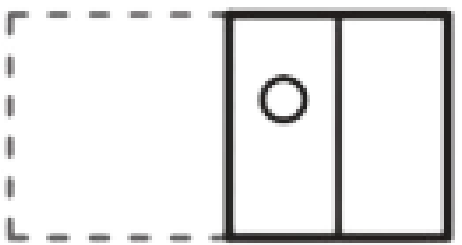
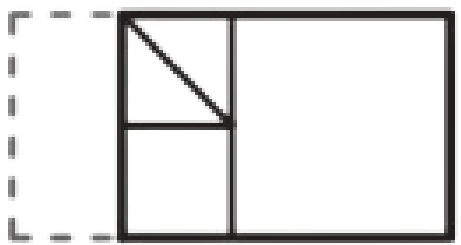
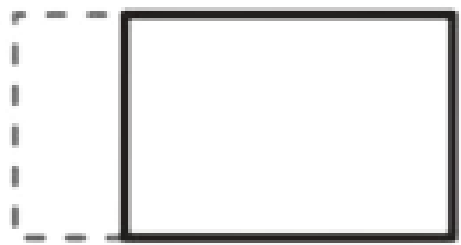
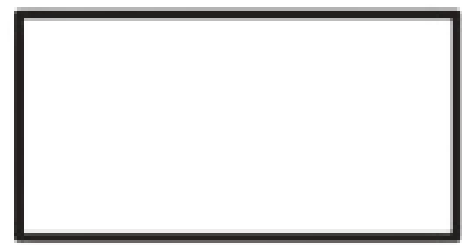

۴

۳

۲

۱





# صورت کھینکریں

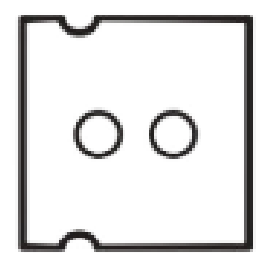
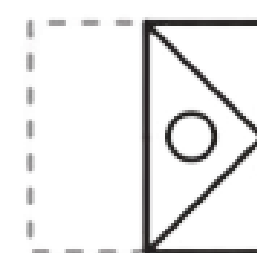
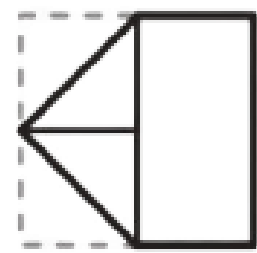
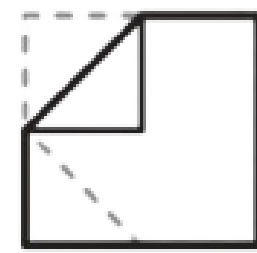
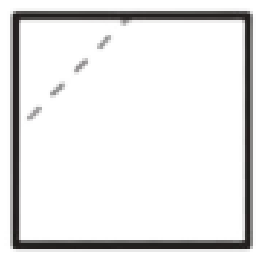

۴

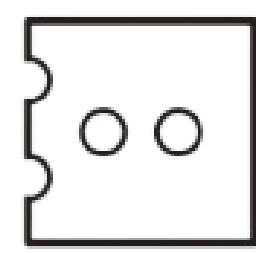

۳

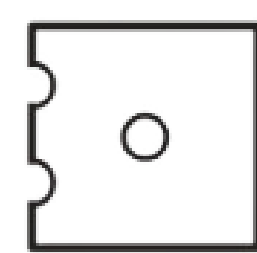

۲

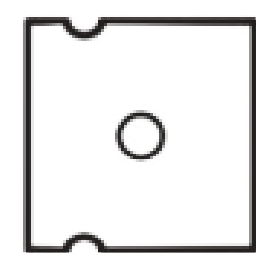

۱





# صورت کھینکریں

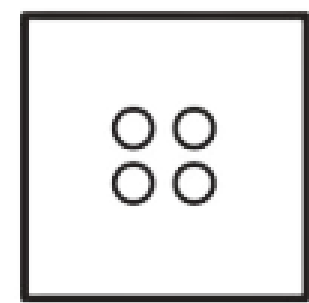
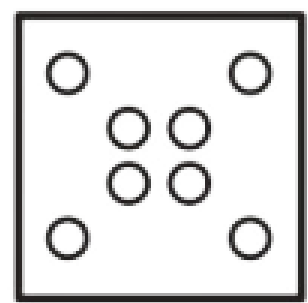
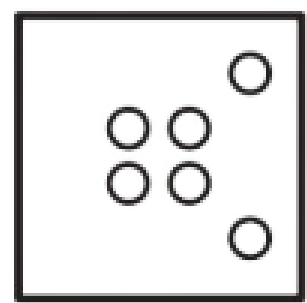
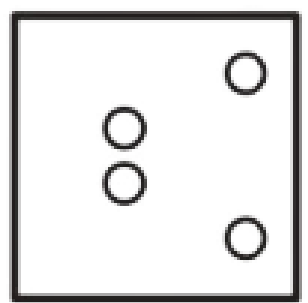
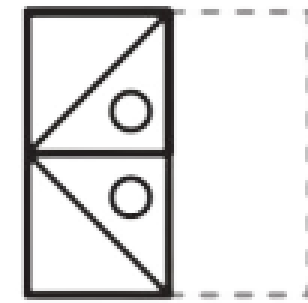
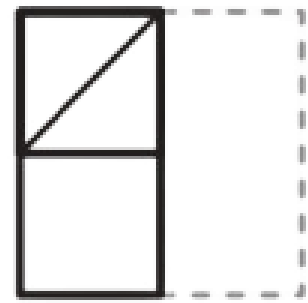
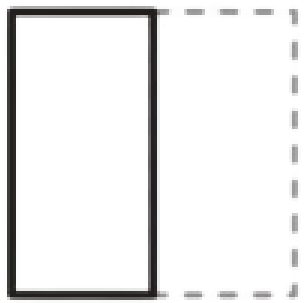
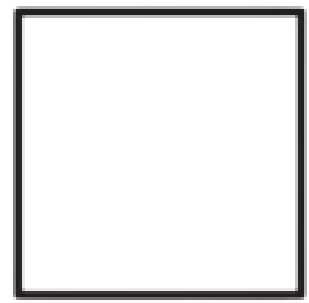

۴

۶

۸

۱





# صورت کھینکریں

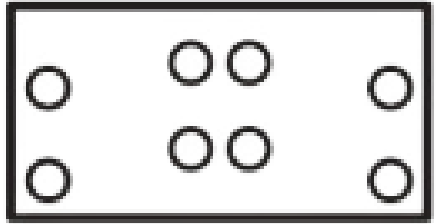
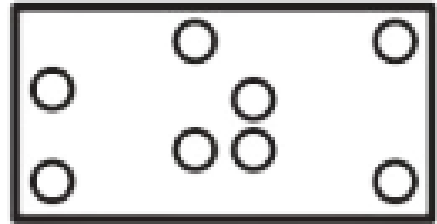
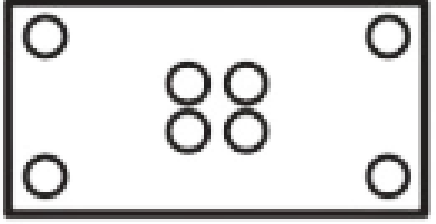
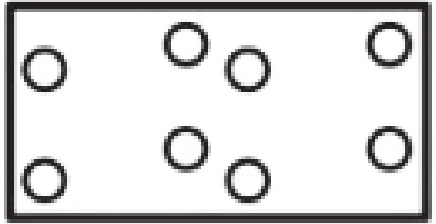
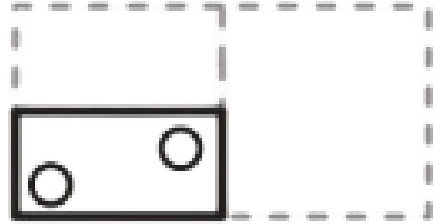
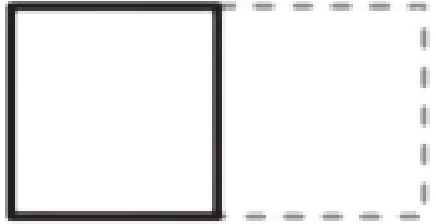
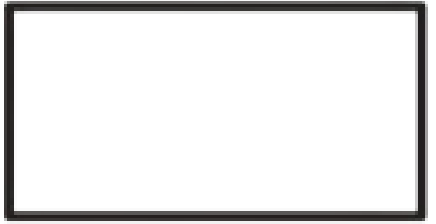

۴

۳

۲

۱





# هوئج اكمپلر

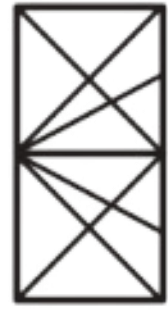
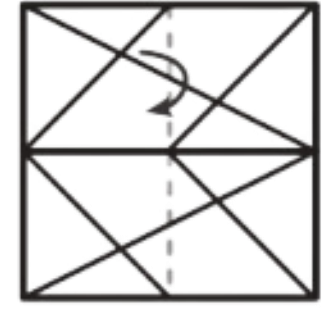

۴

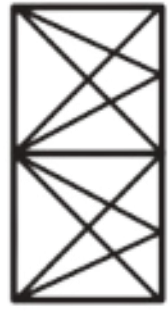

۳

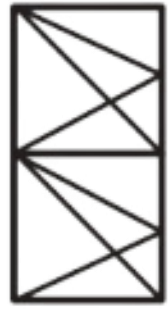

۲



۱







# صورت کھینکیں

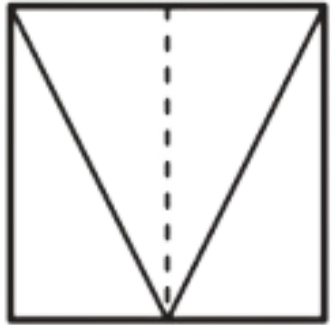

۴



۳



۲



۱





# صورت کھینچیں

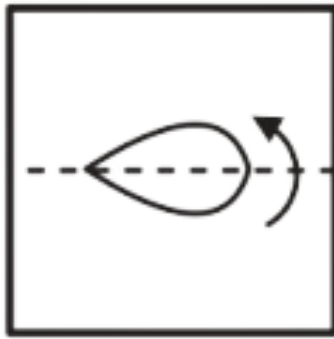

۴



۳



۲



۱





# هوئج اكمپلر

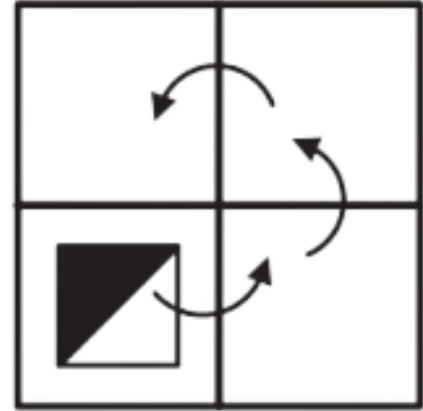

٤



٣



٢



١





# صورت کھینکریں

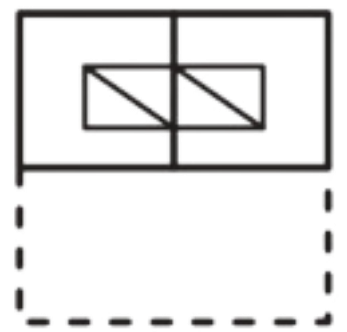
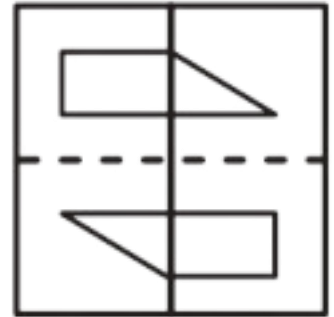

۴

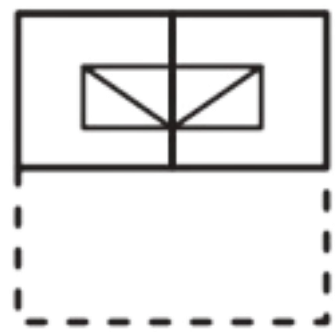

۳

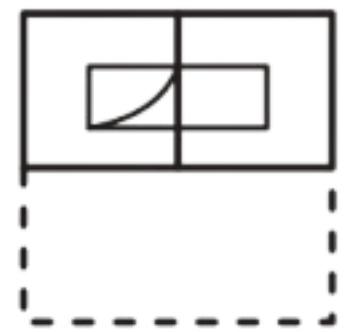

۲

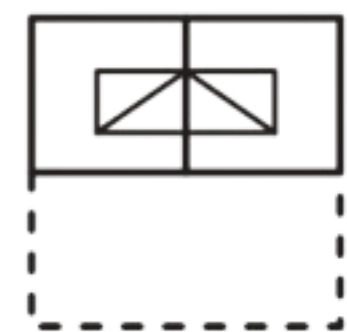

۱





# صورت کھینکریں

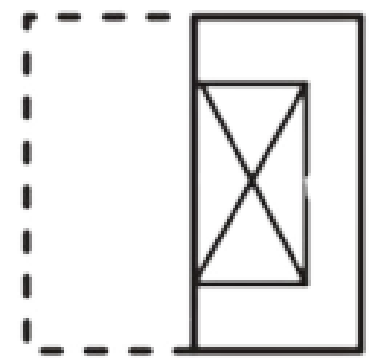
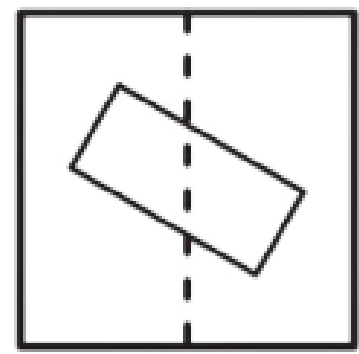

۴

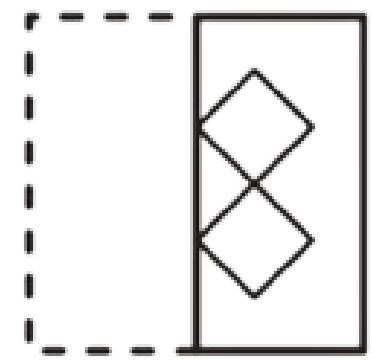

۳

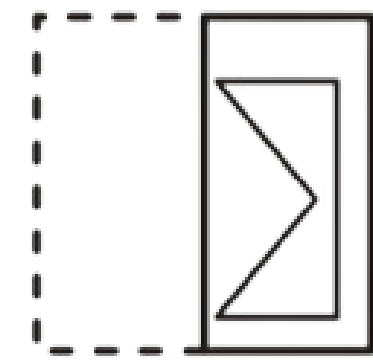

۲

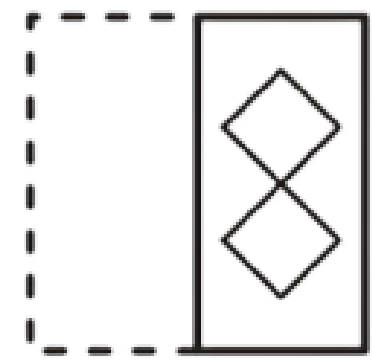

۱





$1+1=2$   
 $1 \times 2 =$   
 $x = +$

# هوش کمپلرس

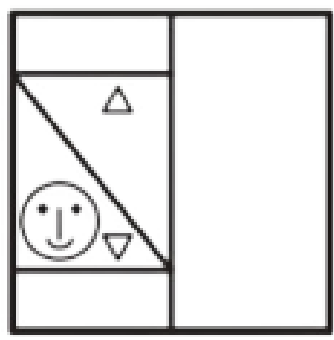
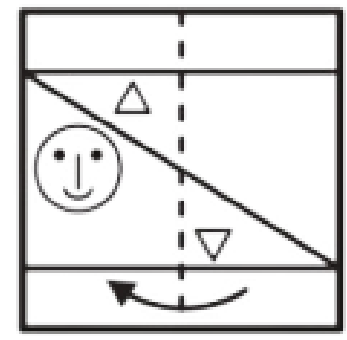

٤

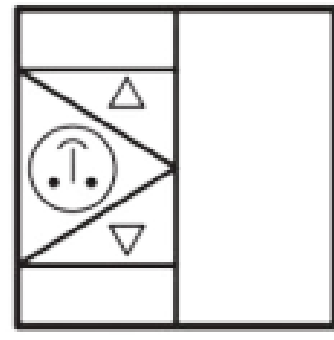

٣

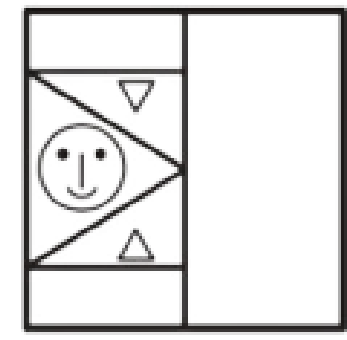

٢

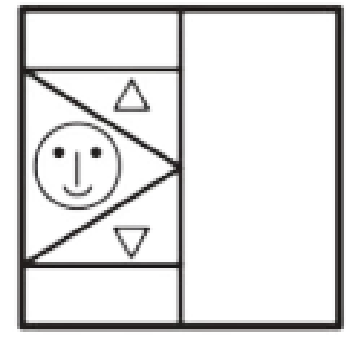

١





# ھوش ڪمپليڪس

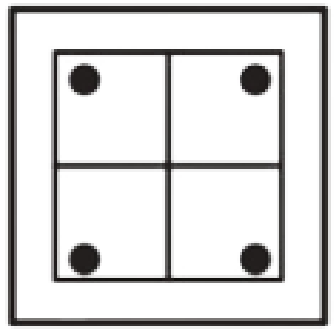
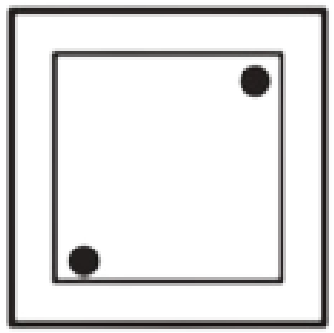

۴

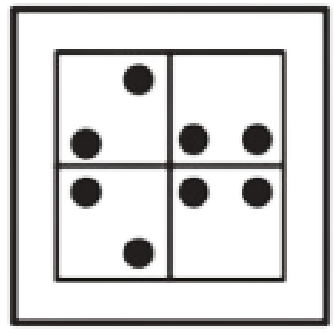

۳

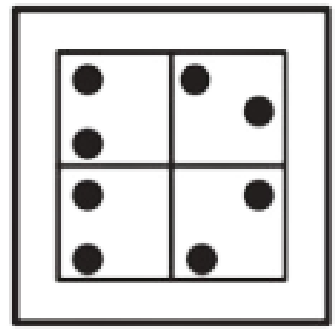

۲

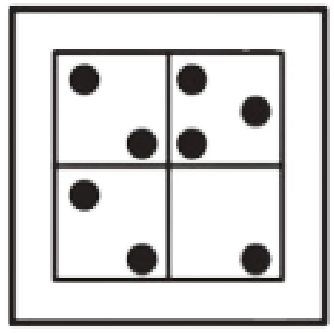

۱





$1+1=2$   
 $1+2=$   
 $x=+$

# هوئڻ ڪمپليٽ ڪريو

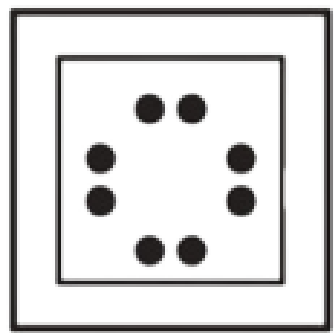
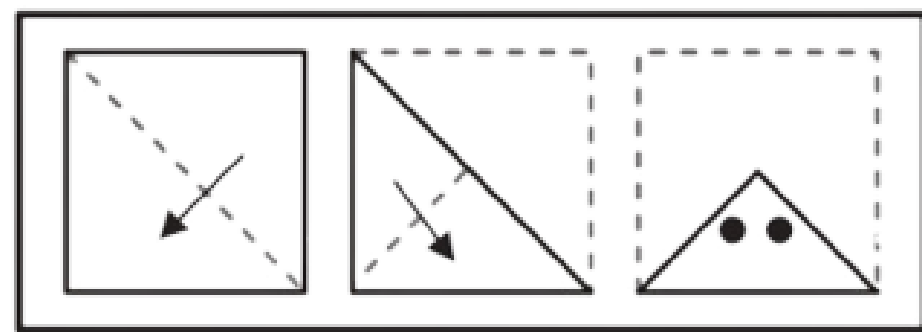

۴

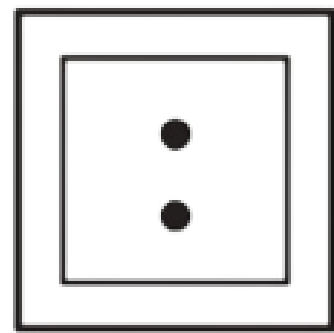

۳

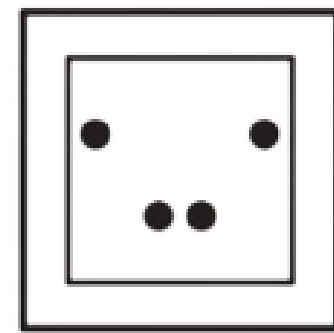

۲

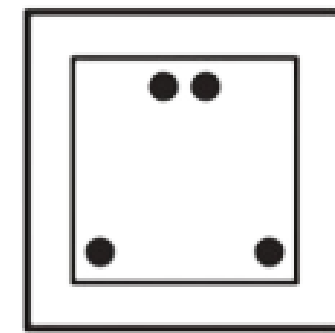

۱







1+1=2  
1+2=3  
x=+

# ھوش اکیلیک

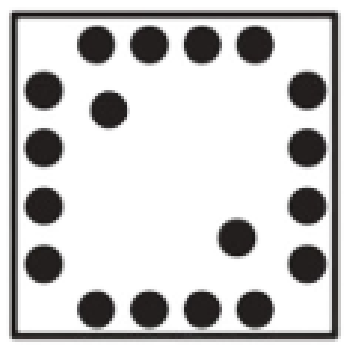
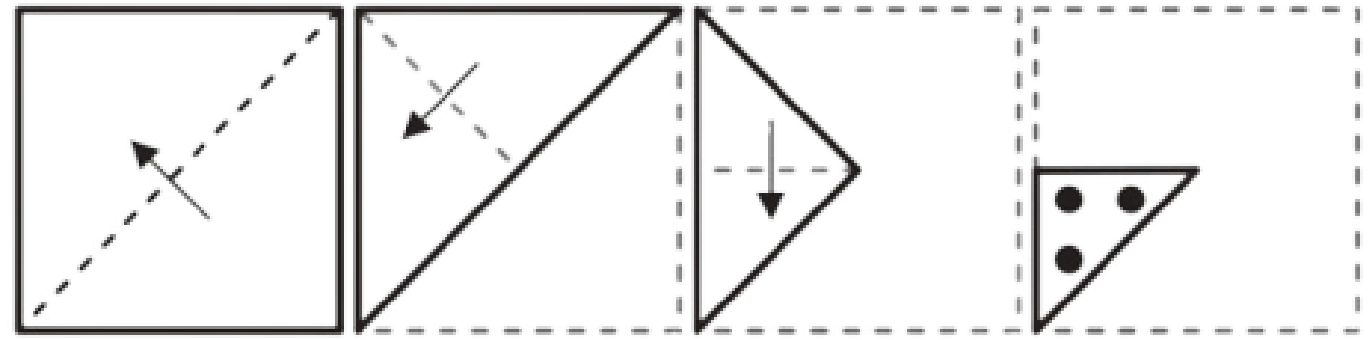

۴

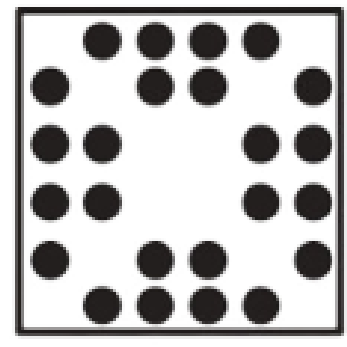

۳

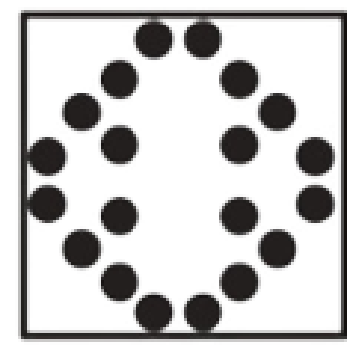

۲

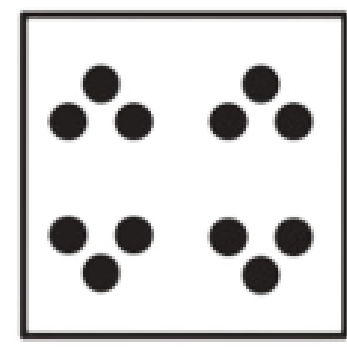

۱





# صورت کھینکریں

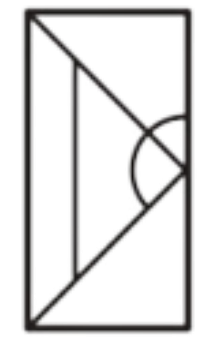
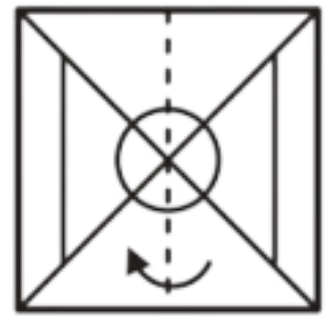

۴



۳

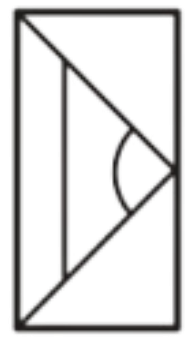

۲



۱

